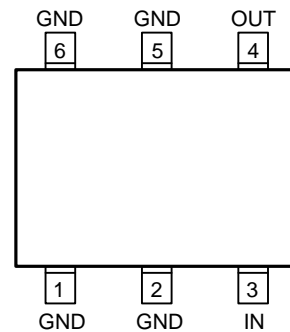
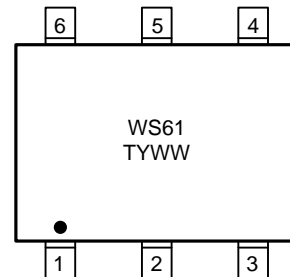

**WS3202E**
**Over voltage and over current protection IC**
[Http://www.sh-willsemi.com](http://www.sh-willsemi.com)
**Descriptions**

The WS3202E is an Over-Voltage-Protection (OVP) and Over-Current-Protection (OCP) device. The device will switch off internal MOSFET to disconnect IN to OUT to protect load when any of input voltage, input current over the threshold. The Over temperature protection (OTP) function monitors chip temperature to protect the device.

The WS3202E is available in SOT-23-6L package. Standard products are Pb-free and Halogen-free.

**SOT-23-6L**

**Pin configuration (Top view)**

**WS61** = Device code  
**T** = Series code  
**Y** = Year  
**WW** = Week  
**Marking**

**Features**

- High voltage technology
- Maximum input voltage : 25V
- Output power ON time : 8ms (Typ.)
- OVP threshold : 6.1V (Typ.)
- OVP response time : <1us
- OCP threshold : 2A (Min.)
- Output discharge
- Package : SOT-23-6L

**Applications**

- GPS
- PMP
- MID
- PAD
- Digital cameras
- Digital Videos

**Order information**

Device	Package	Shipping
WS3202E61-6/TR	SOT-23-6L	3000/Reel&Tape

Typical applications

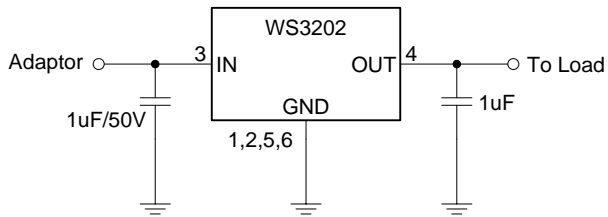

Pin descriptions

Pin No.	Symbol	Descriptions
1, 2, 5, 6	GND	Power ground
3	IN	Input pin, connect to AC adaptor or VBUS. A 1uF low ESR ceramic capacitor or larger must be connected as close as to this pin. It is recommended to use 50V capacitor or according to application.
4	OUT	Output pin, Connect to load.

Block diagram

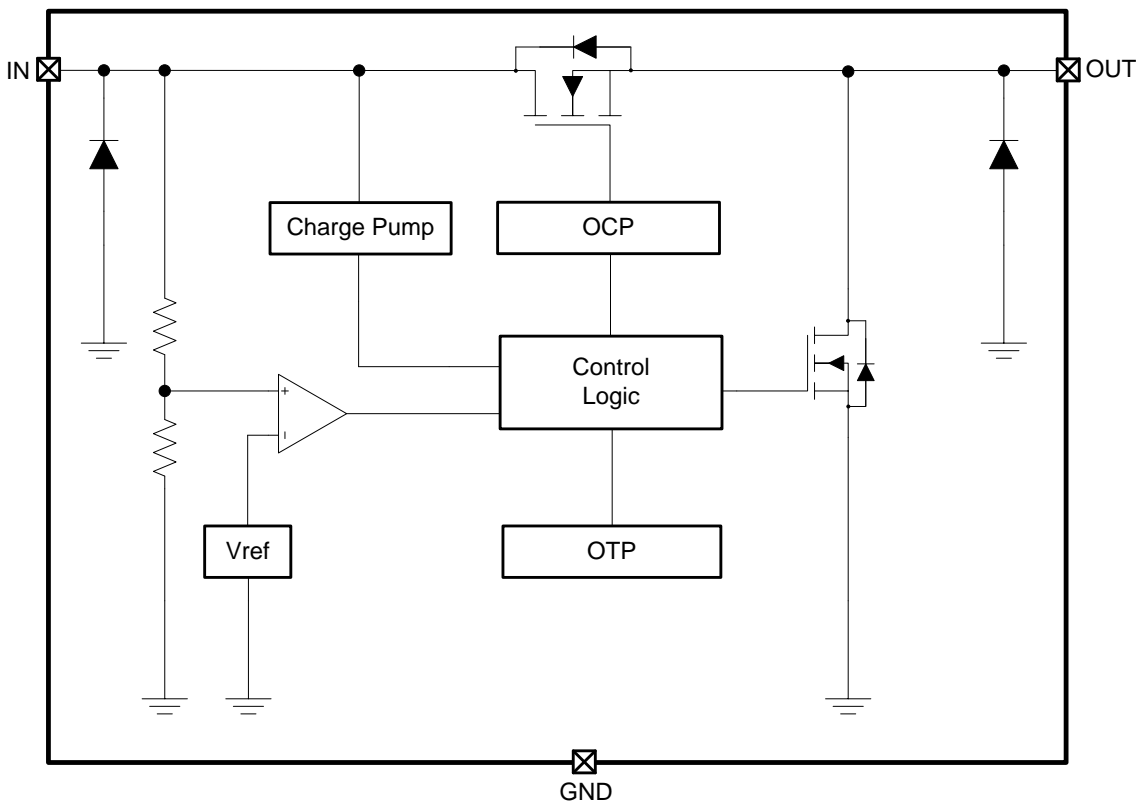

**Absolute maximum ratings**

Parameter	Symbol	Value	Unit
Input voltage (IN pin)	$V_{IN}$	-0.3 ~ 25	V
Output voltage (OUT pin)	$V_{OUT}$	-0.3 ~ 6.5	V
Power dissipation *1 *3	$P_D$	0.5	W
Power dissipation *2 *3		0.3	W
Thermal resistance *1	$R_{\theta JA}$	250	°C/W
Thermal resistance *2		416	°C/W
Junction temperature	$T_J$	150	°C
Lead temperature(10s)	$T_L$	260	°C
Storage temperature	$T_{stg}$	-55 ~ 150	°C
ESD Ratings	HBM	±8000	V
	MM	±1000	V

**Note:** These are stress ratings only. Stresses exceeding the range specified under “Absolute Maximum Ratings” may cause substantial damage to the device. Functional operation of this device at other conditions beyond those listed in the specification is not implied and prolonged exposure to extreme conditions may affect device reliability.

\*1: Surface mounted on FR-4 Board using 1 square inch pad size, dual side, 1oz copper

\*2: Surface mounted on FR-4 board using minimum pad size, 1oz copper

\*3: Power dissipation is calculated by  $P_D = (V_{IN} - V_{OUT}) \times I_{OUT}$

**Recommend operating conditions (Ta=25°C, unless otherwise noted)**

Parameter	Symbol	Value	Unit
Input voltage	$V_{IN}$	3 ~ 24	V
Output current	$I_{OUT}$	1.5	A
Ambient operating temperature	$T_{opr}$	-40 ~ 85	°C

**Electronics Characteristics (Ta=25°C, unless otherwise noted)**

Parameter	Symbol	Test conditions	Min.	Typ.	Max.	Unit
<b>DC characteristics and Power-ON-Reset</b>						
Input quiescent current	$I_Q$	$V_{IN}=5V, I_{OUT}=0A$		280	350	$\mu A$
IN-to-OUT ON resistance *3	$R_{ON}$	$V_{IN}=5V, I_{OUT}=0.7A$		190	250	$m\Omega$
Output discharge resistance	$R_{DISCHARGE}$			500		$\Omega$
Under voltage lock out threshold	UVLO	$V_{IN}$ increasing from 0~3V	2.3		2.8	V
Under voltage lock out hysteresis	$V_{HYS-UVLO}$	$V_{IN}$ decreasing from 3~0V	200	250	300	mV
Output power-on time	$T_{ON}$	$V_{IN} = 0 \rightarrow 5V$ to output ON	6	8	10	ms
<b>Input Over-Voltage-Protection (OVP)</b>						
OVP threshold	$V_{OVP}$	$V_{IN}$ increasing from 5~7V	5.8	6.1	6.4	V
OVP hysteresis	$V_{HYS-OVP}$	$V_{IN}$ decreasing from 7~5V	200	300	400	mV
OVP active time	$T_{OVP}$	$V_{IN} = 5 \rightarrow 10V$			1	$\mu s$
OVP recovery time	$T_{ON(OVP)}$	$V_{IN} = 10 \rightarrow 5V$ to output ON	6	8	10	ms
<b>Input Over-Current-Protection (OCP)</b>						
OCP threshold	$I_{OCP}$		2.0			A
<b>Over-Temperature-Protection (OTP)</b>						
OTP threshold				165		$^{\circ}C$
OTP hysteresis				40		$^{\circ}C$

\*3: Single Pulse, Pulse width=10ms

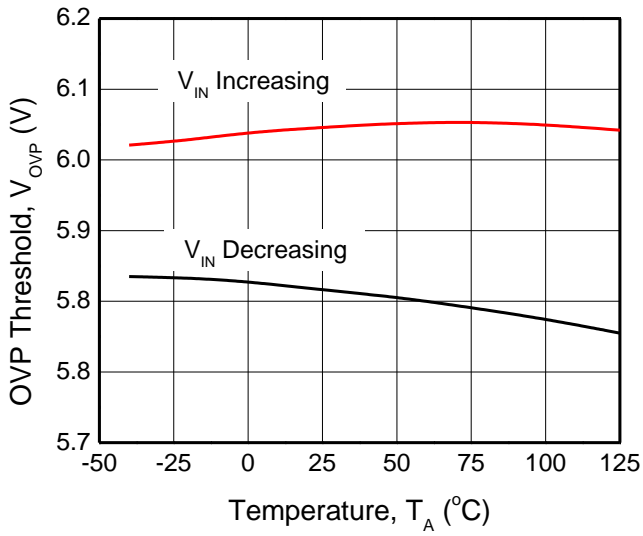
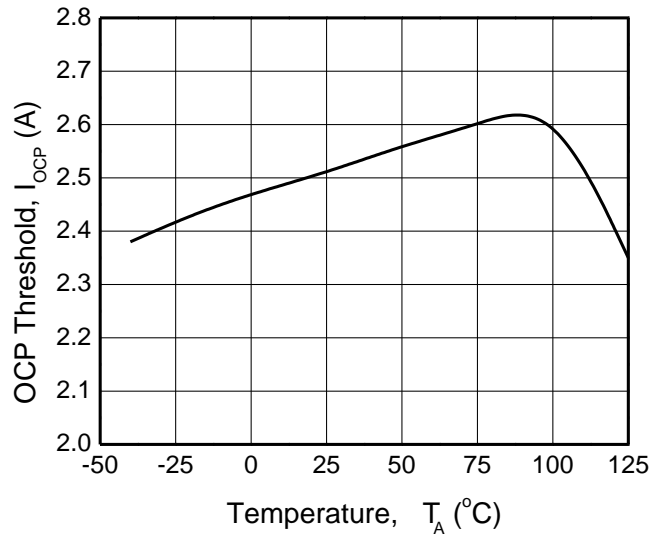
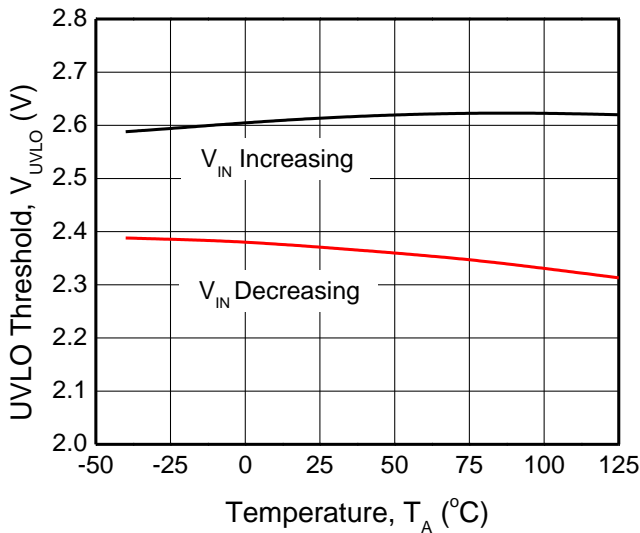
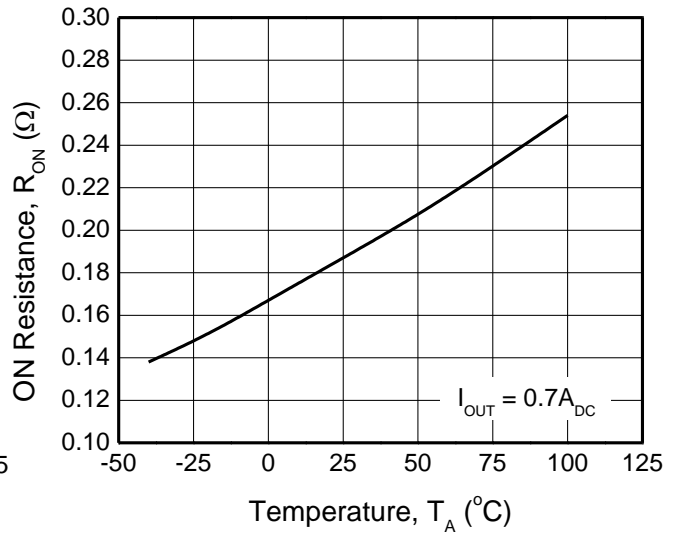
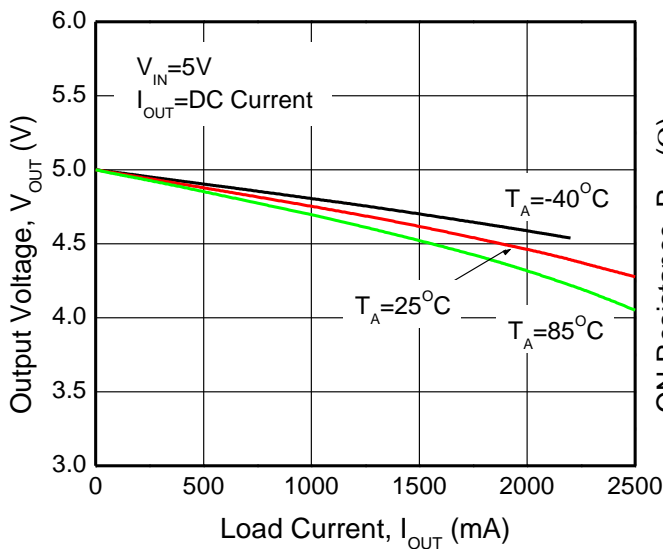
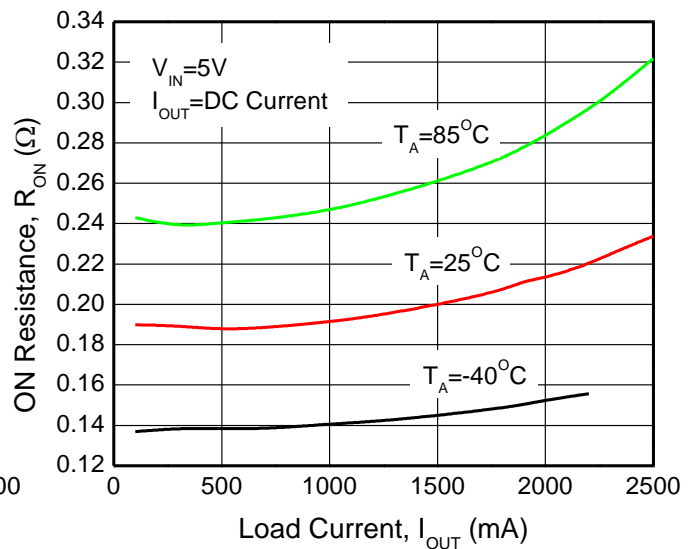
**Typical Characteristics (Ta=25°C, unless otherwise noted)**

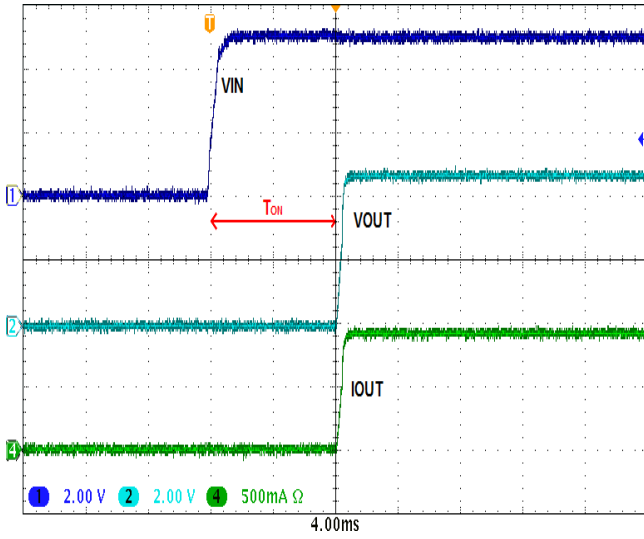
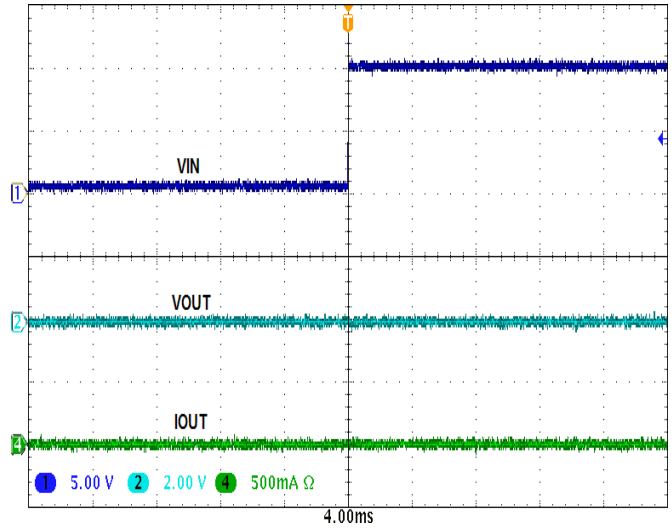
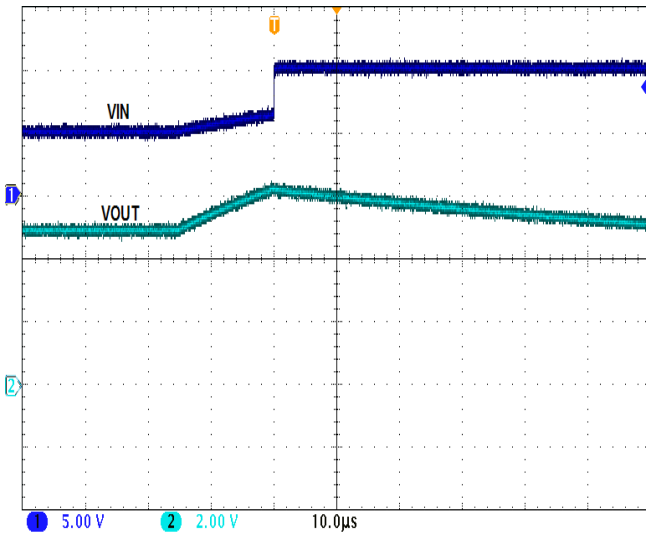
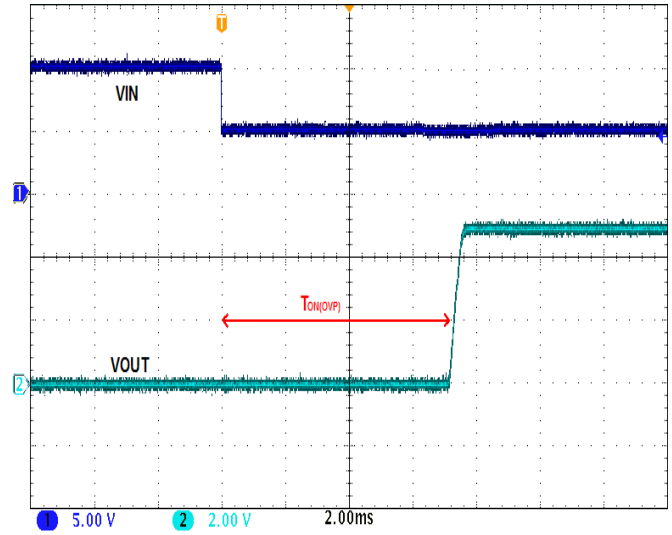
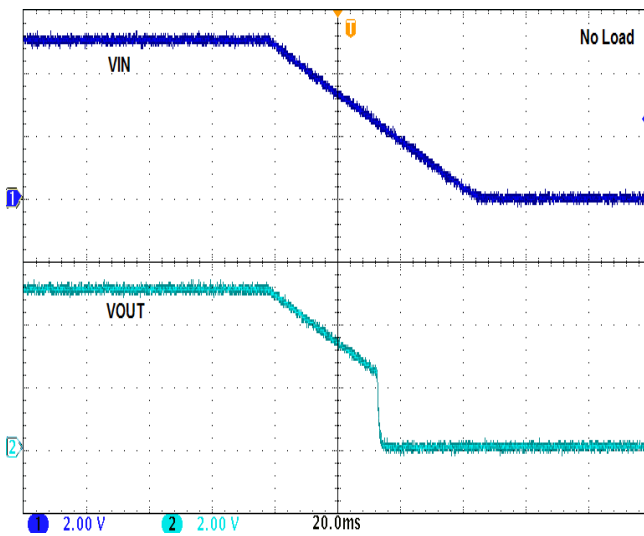
**OVP threshold vs. Temperature**

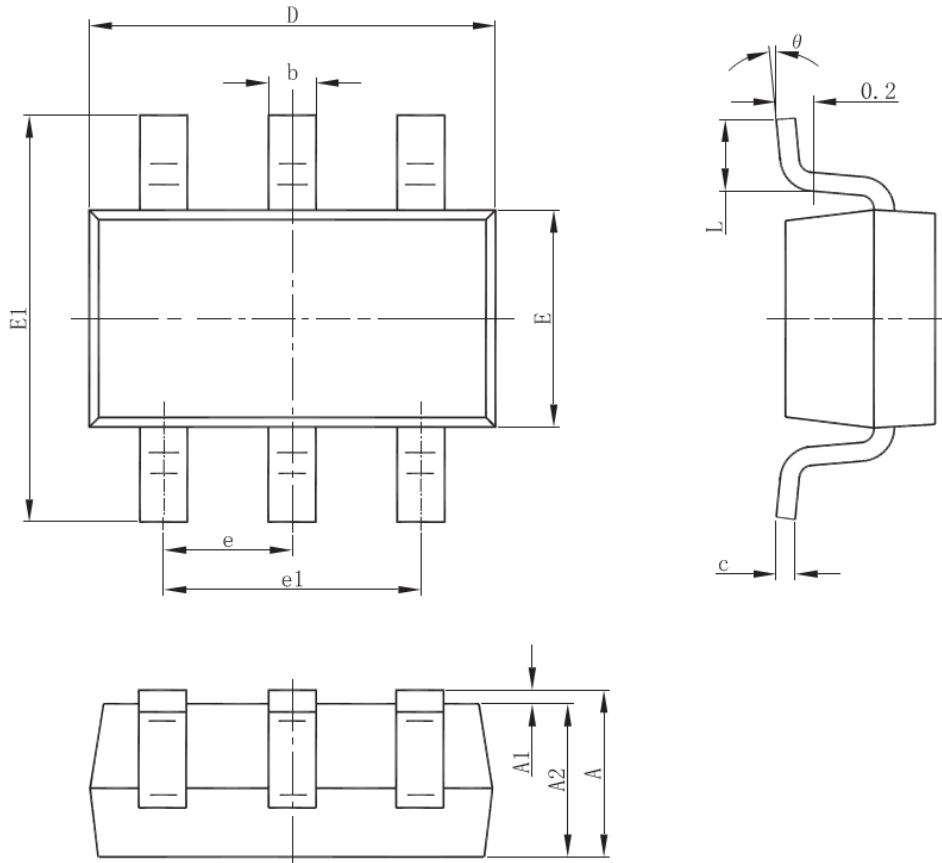
**OCP threshold vs. Temperature**

**UVLO threshold vs. Temperature**

**IN-to-OUT ON resistance vs. Temperature**

**Output voltage vs. Output current**

**ON resistance vs. Output current**

**Normally Power ON**

**Power ON with Input Overvoltage**

**OVP Active Time**

**OVP Recovery Time**

**Normally Power OFF**

**Package outline dimensions**
**SOT-23-6L**

Symbol	Dimensions In Millimeters		
	Min.	Typ.	Max.
A	1.050	-	1.250
A1	0.000	-	0.100
A2	1.050	-	1.150
b	0.300	0.400	0.500
c	0.100	-	0.200
D	2.820	2.900	3.020
E	1.500	1.600	1.700
E1	2.650	2.800	2.950
e	0.950 Typ.		
e1	1.800	1.900	2.000
L	0.300	-	0.600
θ	0°	-	8°