

WD3148

White LED Driver with PWM Brightness Control in Tiny Package

[Http://www.sh-willsemi.com](http://www.sh-willsemi.com)

With a 40-V rated integrated power switch MOSFET, the WD3148 is a boost converter that drives up to 10 White LEDs in series. The WD3148 operates at 600kHz fixed switching frequency to reduce output ripple, improve conversion efficiency, and allows for the use of small external components.

The default Full-Scale White LED current is set by an external sensor resistor with regulated 200mV feedback voltage, as shown in typical application. During operation, the LED current can be controlled using the Pulse Width Modulation (PWM) signal applied on the EN pin, through which the PWM Duty-Cycle determines the feedback reference voltage and then the White LED current. In PWM mode, the WD3148 does not burst the LED current; therefore, it does not generate audible noises on the ceramic output capacitor. For maximum protection, the device features integrated open LED protection that disables the WD3148 to prevent the output voltage from exceeding the absolute maximum ratings during open LED conditions.

The WD3148 is available in a PCB space saving DFN 2mm x 2mm-6L Package with bottom thermal pad. Standard product is Pb-free and Halogen-free.

Features

- 2.7V~5.5V Input voltage range
- 38V Open LED Protection
- 200mV Reference Voltage
- 600kHz Switching frequency
- Up to 91% Efficiency
- PWM Brightness Control
- PWM Dimming Duty ranges from 0.3% to 100%
- Built-in Soft-Start and Over-Current limit

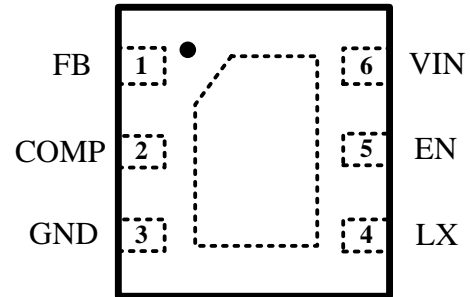

DFN 2mm x 2mm-6L
Pin configuration (Top view)

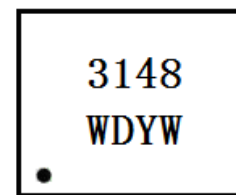

Marking

- 3148** = Device Code
Y = Year Code
W = Week Code

Order information

Device	Package	Shipping
WD3148D-6/TR	DFN-2x2-6L	3000/Reel&Tape

Applications

- Smart Phones
- Tablets
- Portable games

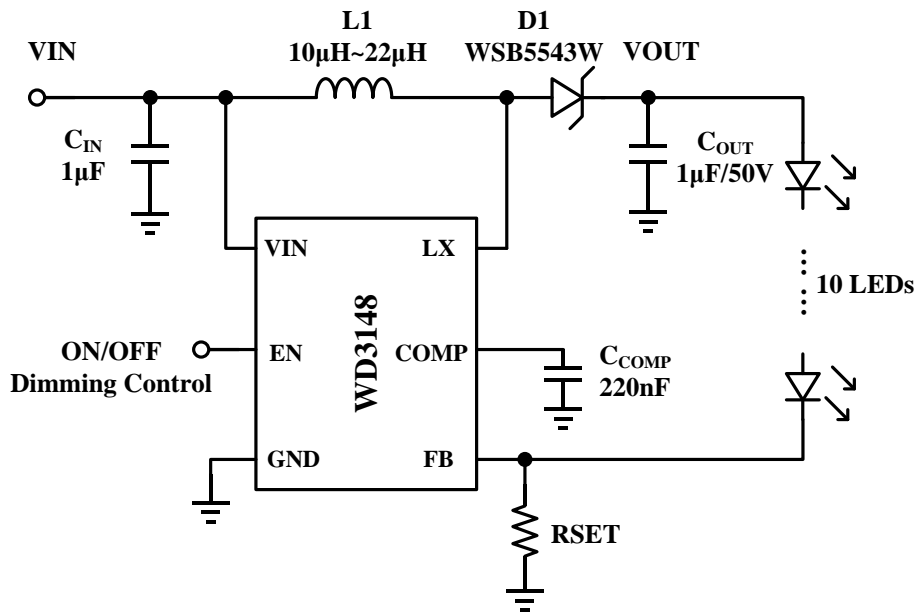
Typical applications

Pin descriptions

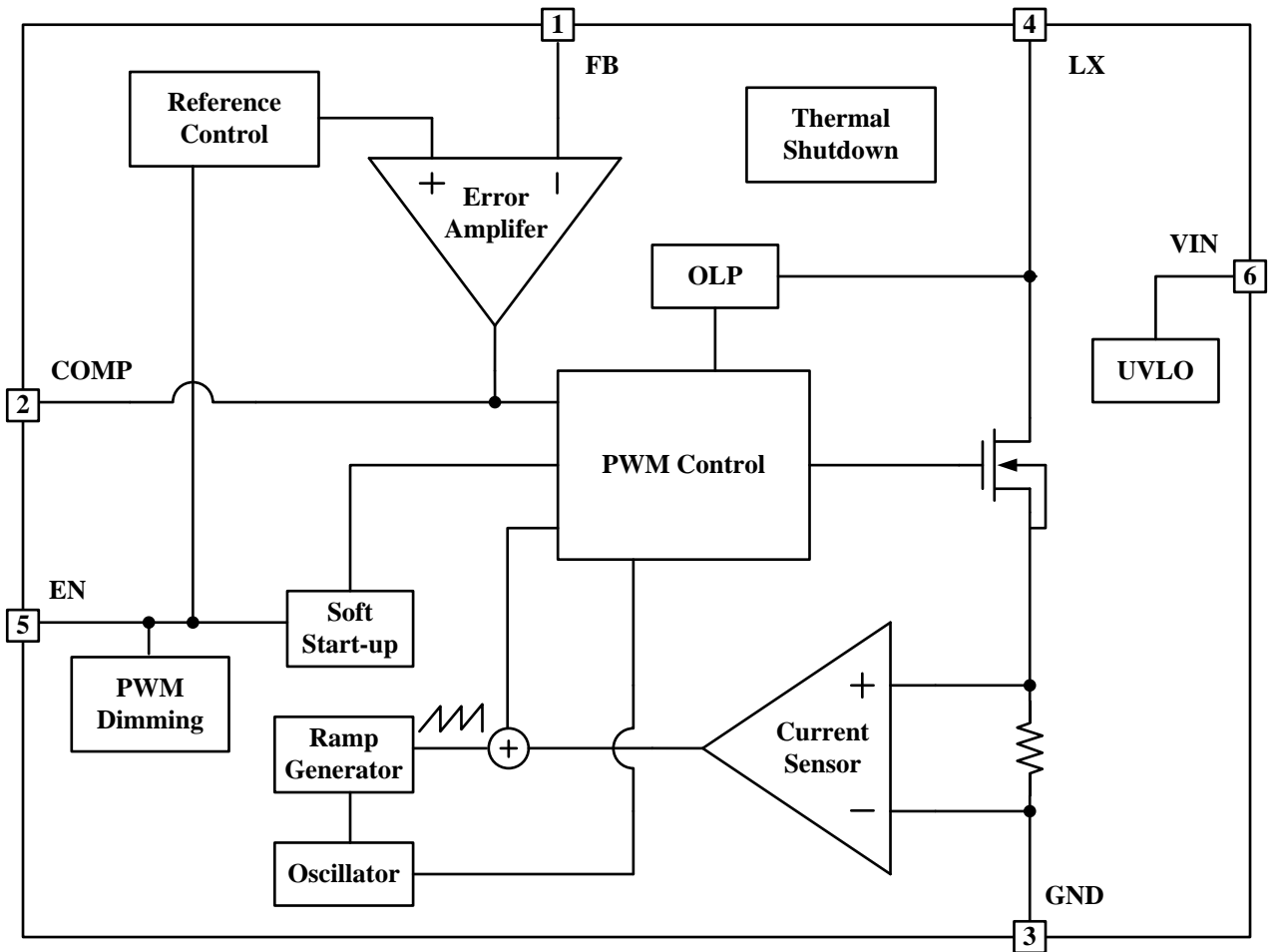
Symbol	Pin No.	Descriptions
FB	1	Feedback pin for LED current. Connect the sense resistor from FB to GND
COMP	2	Output of the Error Amplifier. Connect an external capacitor to this pin to compensate the converter
GND	3	Ground
LX	4	Switch pin. Connect the inductor between VIN and LX. This pin is also used to sense output voltage for Open LED Protection
EN	5	Enable pin of boost converter. It also can be used for PWM dimming control
VIN	6	Power supply. Connect VIN to a supply voltage between 2.7V and 5.5V
Thermal Pad	Bottom	The exposed thermal pad should be soldered to the analog ground plane. If possible, use the thermal via to connect to ground plane

Block diagram

Absolute maximum ratings

Parameter	Symbol	Value	Unit
VIN pin voltage range	V_{IN}	-0.3~6.5	V
EN, FB, COMP pin voltage range	-	-0.3~ V_{IN}	V
LX pin voltage range (DC)	-	-0.3~40	V
Power Dissipation – DFN-2x2-6L (Note 1)	P_D	1.5	W
Power Dissipation – DFN-2x2-6L (Note 2)		0.7	W
Junction to Ambient Thermal Resistance – DFN-2x2-6L (Note 1)	$R_{\theta JA}$	65	°C/W
Junction to Ambient Thermal Resistance – DFN-2x2-6L (Note 2)		140	°C/W
Junction temperature	T_J	160	°C
Lead temperature(Soldering, 10s)	T_L	260	°C
Operation temperature	T_{opr}	-40 ~ 85	°C
Storage temperature	T_{stg}	-55 ~ 150	°C

These are stress ratings only. Stresses exceeding the range specified under “Absolute Maximum Ratings” may cause substantial damage to the device. Functional operation of this device at other conditions beyond those listed in the specification is not implied and prolonged exposure to extreme conditions may affect device reliability.

Note 1: Surface mounted on JEDEC high-k Board using 1 square inch pad size, multilayer board with 1-ounce internal power and ground planes and 2-ounce copper trances on top and bottom of the board.

Note 2: Surface mounted on JEDEC low-k Board using 1 square inch pad size, two-layer board with 2-ounce copper traces on top of the board.

Electronics Characteristics ($T_a=25^{\circ}\text{C}$, $V_{IN}=3.6\text{V}$, $V_{EN}=V_{IN}$, $C_{IN}=C_{OUT}=1\mu\text{F}$, unless otherwise noted)

Parameter	Symbol	Test Conditions	Min	Typ	Max	Unit
Supply Current						
Operation Voltage Range	V_{IN}		2.7	--	5.5	V
Under Voltage Lockout	V_{UVLO}	V_{IN} Rising	1.8	2.2	2.5	V
UVLO Hysteresis	$V_{UVLO-HYS}$			0.1		V
Quiescent Current	I_Q	No Switching		0.4	1	mA
Supply Current	I_S	Switching		1	2	mA
Shutdown Current	I_{SD}	$V_{EN} < 0.4\text{V}$			1	μA
Enable and Reference Control						
EN Threshold Voltage	V_{ENL}		0		0.4	V
	V_{ENH}		1.5		V_{IN}	V
EN Pull-down Resistance	R_{EN}			1		$\text{M}\Omega$
EN Shutdown Pulse Width	t_{OFF}	EN High to Low	2.5			ms
Voltage and Current Control						
Feedback Reference	V_{REF}	100% Full Scale	190	200	210	mV
		1% Dimming	2.4		3.6	mV
		0.3% Dimming		1.5		mV
Feedback Input Bias Current	I_{FB}				1	μA
Operation Frequency	f_{OSC}		500	600	700	kHz
Maximum Duty Cycle	D_{MAX}		92	95		%
PWM Dimming Clock Rate		Recommended	5		100	KHz
PWM Dimming Duty Cycle		Recommended	0.3		100	%
Power Switch						
On Resistance	R_{ON}	$V_{IN}=3.6\text{V}$, 100mA		0.4		Ω
N-channel Leakage Current	I_{LN_NFET}	$V_{LX}=40\text{V}$, $T_A=25^{\circ}\text{C}$			1	μA
OC and OLP						
Current Limit	I_{LIM}		0.68	0.85		A
Open LED Protection Threshold	V_{OLP}	LED Open, Measured on LX	36	38	40	V
Thermal Shutdown						
Thermal Shutdown Temperature	T_{SD}			160		$^{\circ}\text{C}$
T_{SD} Hysteresis	T_{SD-HYS}			30		$^{\circ}\text{C}$

Typical Characteristics

($T_a=25^\circ\text{C}$, $V_{IN}=3.6\text{V}$, $V_{EN}=V_{IN}$, $C_{IN}=C_{OUT}=1\mu\text{F}$, 10 LEDs, unless otherwise noted)

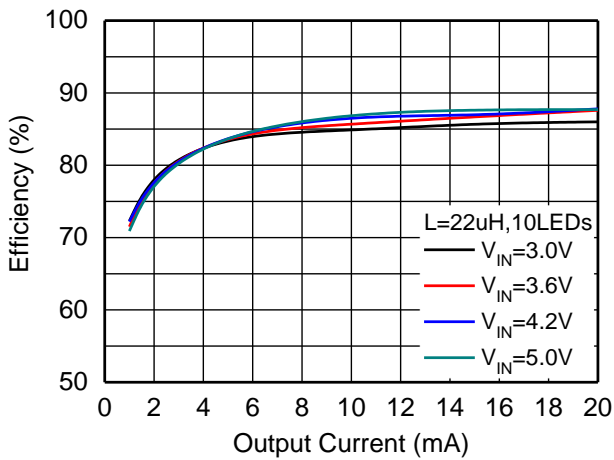

Efficiency vs. Output Current

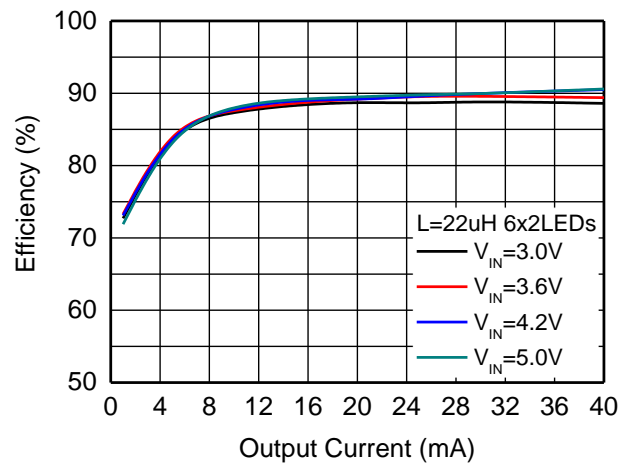

Efficiency vs. Output Current

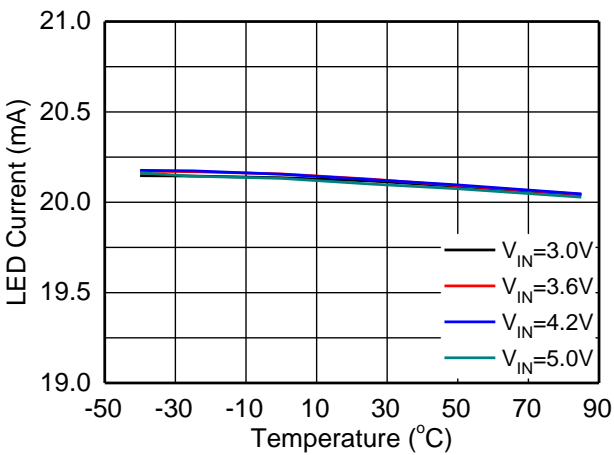

LED Current vs. Temperature

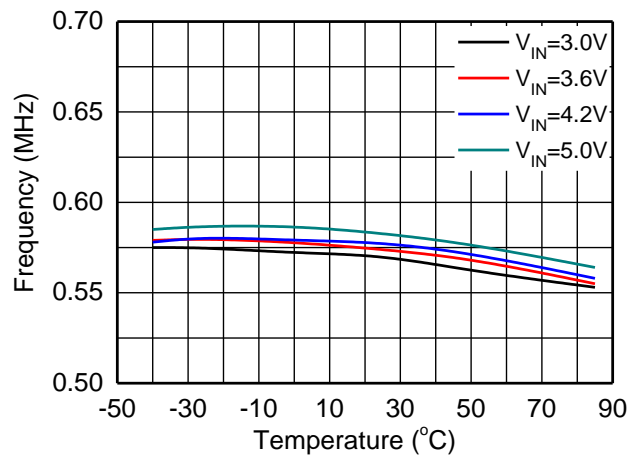

Frequency vs. Temperature

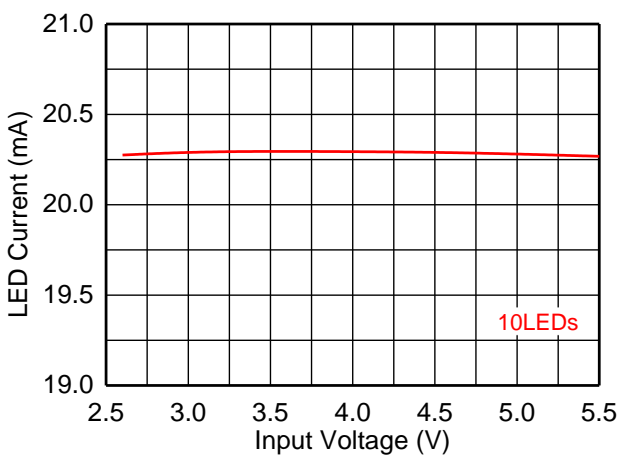

LED Current vs. Supply Voltage

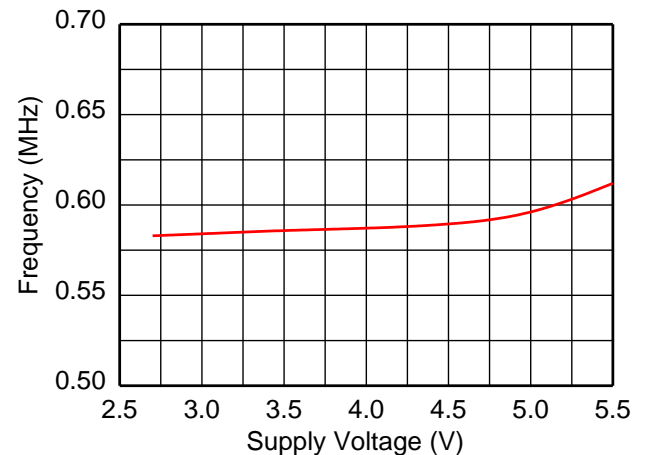

Frequency vs. Supply Voltage

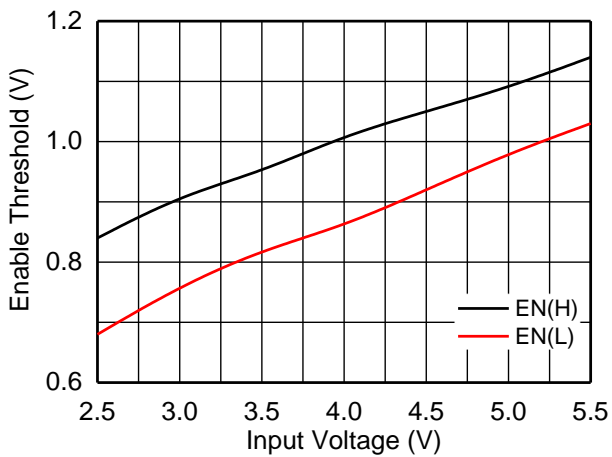
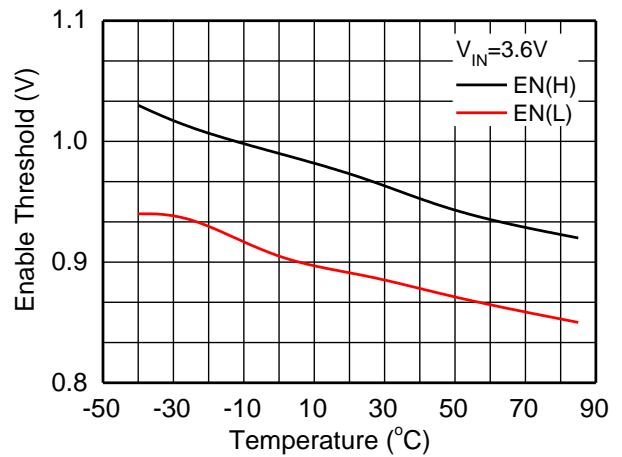
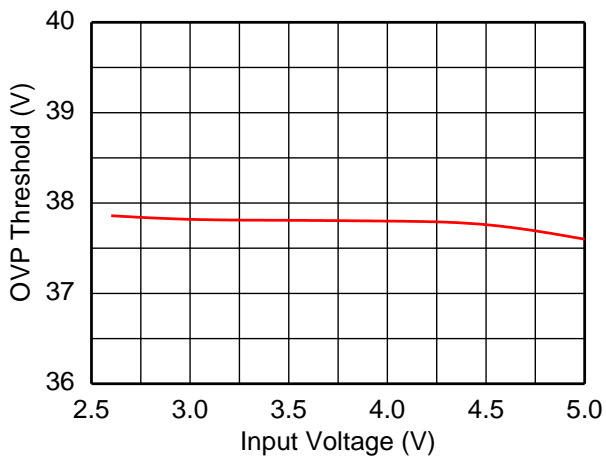
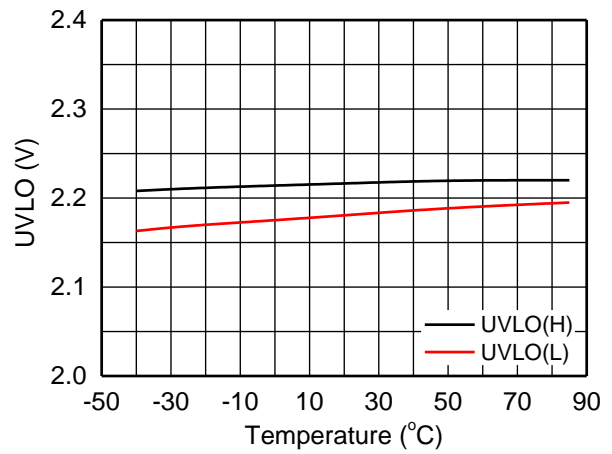
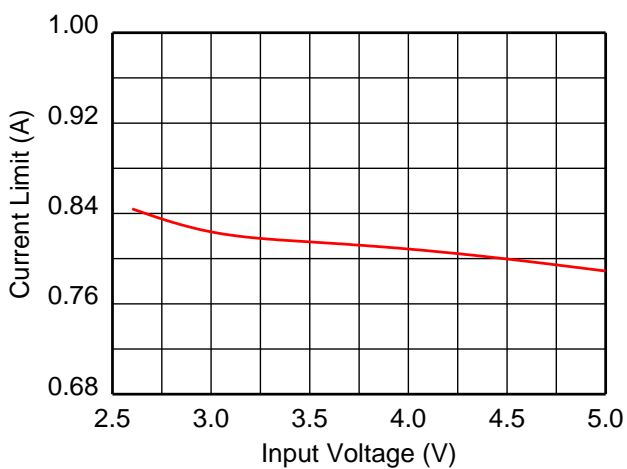
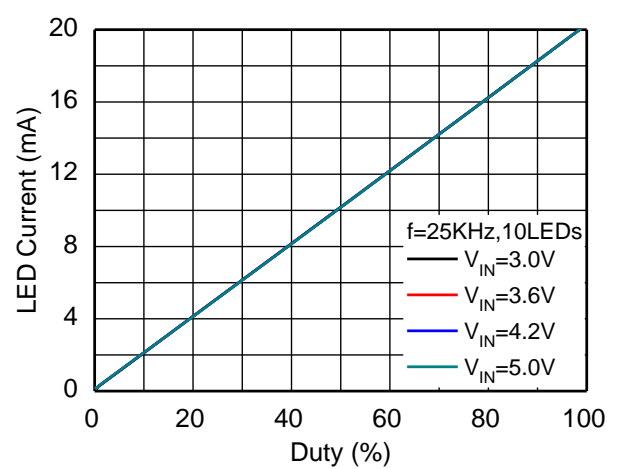
Enable Threshold vs. Supply Voltage

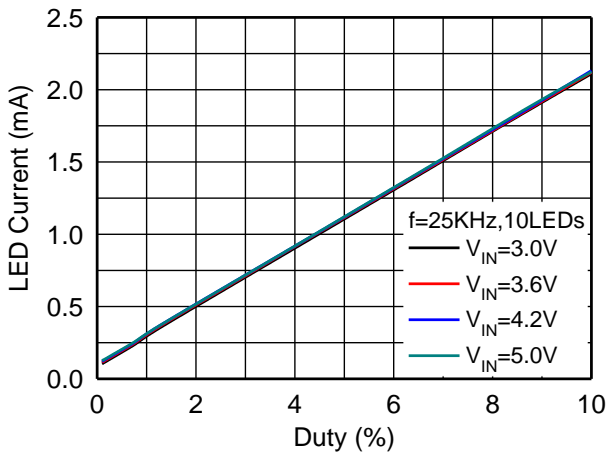
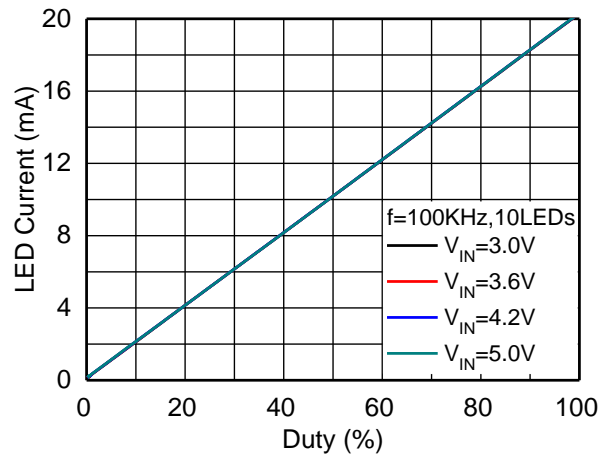
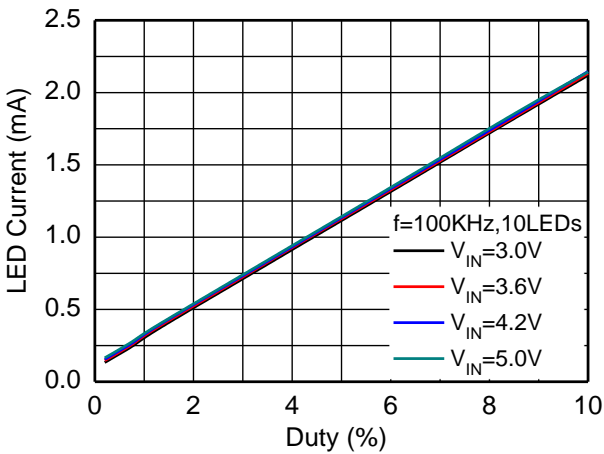
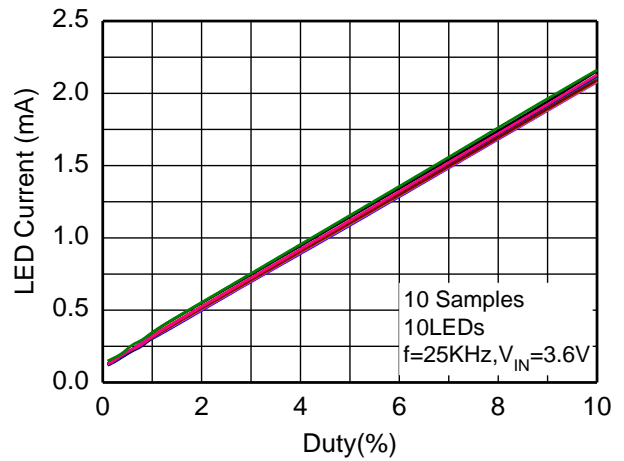
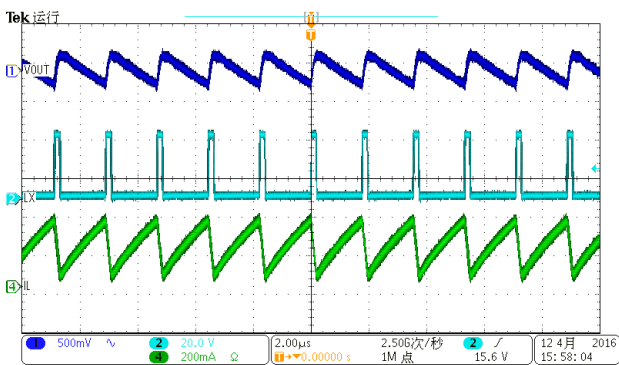
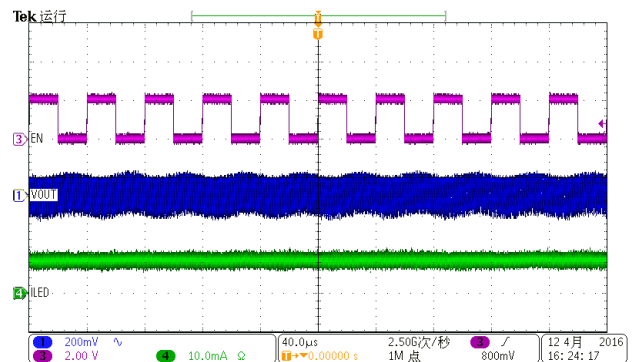
Enable Threshold vs. Temperature

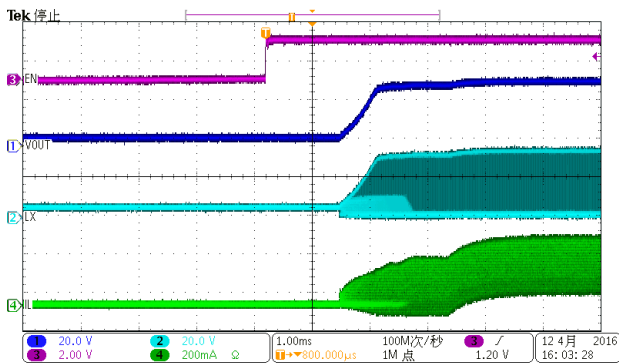
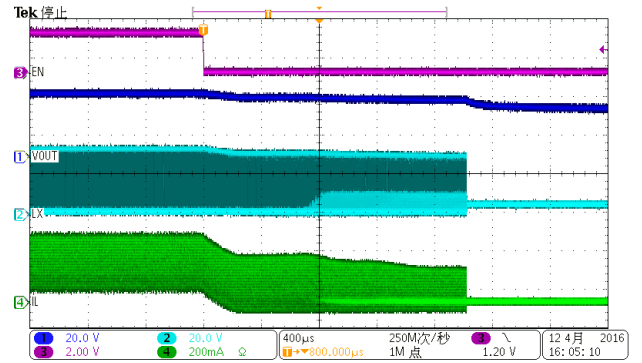
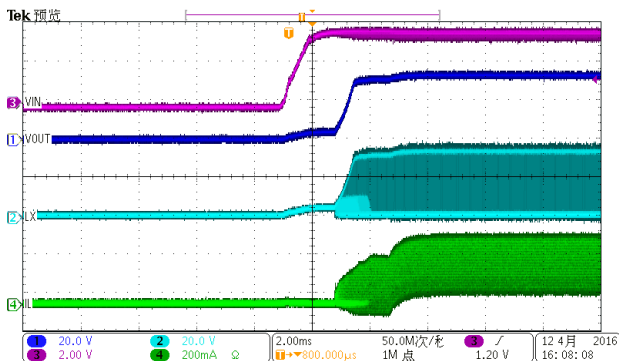
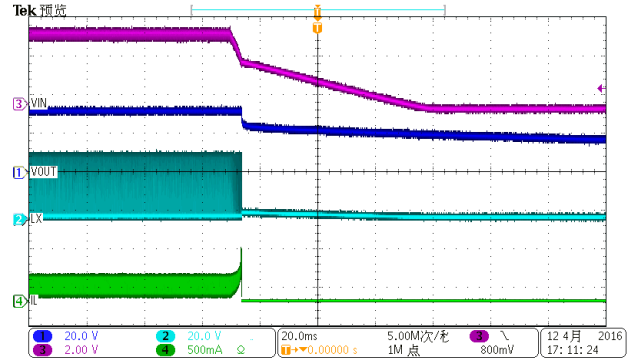
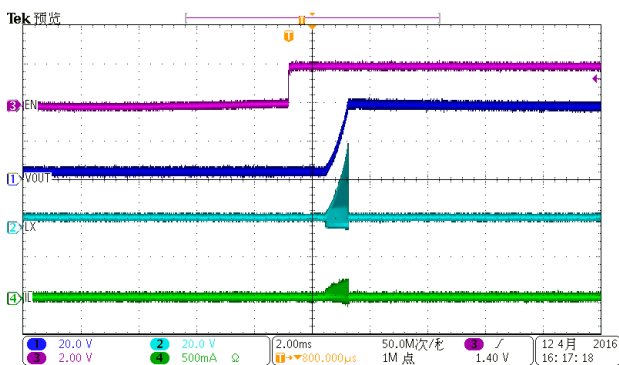
OLP Threshold vs. Supply Voltage

UVLO vs. Temperature

Current Limit vs. VIN

PWM Dimming Linearity

PWM Dimming Linearity

PWM Dimming Linearity

PWM Dimming Linearity

PWM Dimming Distribution

Operation Waveforms

PWM Dimming Waveforms

Start-Up from EN

Shut-Down from EN

Start-Up from VIN

Shut-Down from VIN

Start-Up with LED Open

Operation Information

Operation

The WD3148 is a high efficiency, high output voltage boost converter in a small package size. The device is ideal for driving white LED in series. The serial LED connection provides even illumination by sourcing the same output current through all LEDs, eliminating the need for expensive factory calibration. The device integrates 40V/0.8A switch FET and operates in pulse width modulation (PWM) with 600KHz fixed switching frequency. For operation see the block diagram. The duty cycle of the converter is set by the error amplifier output and the current signal applied to the PWM control comparator. The control architecture is based on traditional current-mode control; therefore, slope compensation is added to the current signal to allow stable operation for duty cycles larger than 50%. The feedback loop regulates the FB pin to a low reference voltage (200mV typical), reducing the power dissipation in the current sense resistor.

Soft Start-up

The WD3148 Build-in Soft-Start function limits the inrush current while the device turn-on.

Open LED Protection

Open LED protection circuitry prevents IC damage as the result of white LED disconnection. The WD3148 monitors the voltage at the LX pin and FB pin during each switching cycle. The circuitry turns off the switch FET and shuts down the IC when both of the following conditions persist for 4 switching clock cycles: (1) the LX voltage exceeds the V_{OVp} threshold and (2) the FB voltage is less than half of regulation voltage. Then, the WD3148 turns off the power switch FET and shuts down IC until EN or power supply is recycled to enable IC.

Shutdown

The WD3148 enters shutdown mode when the EN voltage is logic low for more than 2.5ms. During

shutdown, the input supply current for the device is less than 1 μ A (max). Although the internal FET does not switch in shutdown, there is still a DC current path between the input and the LEDs through the inductor and Schottky diode. The minimum forward voltage of the LED array must exceed the maximum input voltage to ensure that the LEDs remain off in shutdown. However, in the typical application with two or more LEDs, the forward voltage is large enough to reverse bias the Schottky and keep leakage current low.

Current Program

The FB voltage is regulated by a low 0.2V reference voltage. The LED current is programmed externally using a current-sense resistor in series with the LED string. The value of the R_{SET} is calculated using Equation 1:

$$I_{LED} = \frac{V_{FB}}{R_{SET}} = \frac{200mV}{R_{SET}} \quad (1)$$

Where

I_{LED} = output current of LEDs

V_{FB} = regulated voltage of FB

R_{SET} = current sense resistor

The output current tolerance depends on the FB accuracy and the current sensor resistor accuracy.

PWM Brightness Dimming

When the EN pin is constantly high, the FB voltage is regulated to 200mV typically. However, the EN pin allows a PWM signal to reduce this regulation voltage; therefore, it achieves LED brightness dimming. The relationship between the duty cycle and FB voltage is given by Equation 2.

$$V_{FB} = \text{Duty} \times 200mV \quad (2)$$

Where

Duty = Duty Cycle of the PWM signal

200mV = Internal Reference Voltage

As shown in Figure 1, the IC chops up the internal 200mV reference voltage at the duty cycle of the PWM signal. The pulse signal is then filtered by an internal low pass filter. The output of the filter is connected to the error amplifier as the reference voltage for the FB pin regulation. Therefore, although a PWM signal is used for brightness dimming, only the WLED DC current is modulated, which is often referred as analog dimming. This eliminates the audible noise which often occurs when the LED current is pulsed in replica of the frequency and duty cycle of PWM control. Unlike other scheme which filters the PWM signal for analog dimming, WD3148 regulation voltage is independent of the PWM logic voltage level which often has large variations.

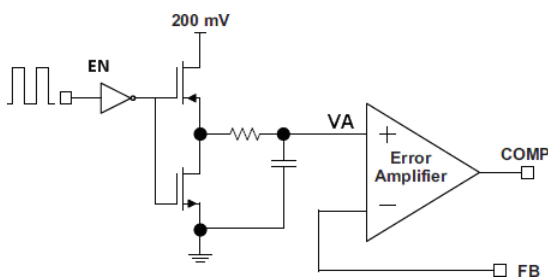

Figure 1. Block Diagram of Programmable FB Voltage Using PWM Signal

For optimum performance, use the PWM dimming frequency in the range of 5kHz to 100kHz. And the recommended minimum PWM Duty Cycle is 1% for stable LED driving and no blind dimming.

Under-Voltage Lockout

An under-voltage lockout prevents operation of the device at input voltages below typical 2.2V. When the input voltage is below the under voltage threshold, the device is shut down and the internal switch FET is turned off. If the input voltage rises by under voltage lockout hysteresis, the IC restarts.

Thermal Shutdown

An internal thermal shutdown turns off the device when the typical junction temperature of 160°C is exceeded. The device is released from shutdown automatically when the junction temperature decreases by 30°C.

Application Information

Maximum Output Current

The overcurrent limit in a boost converter limits the maximum input current and thus maximum input power for a given input voltage. Maximum output power is less than maximum input power due to power conversion losses. Therefore, the current limit setting, input voltage, output voltage and efficiency can all change maximum current output. The current limit clamps the peak inductor current; therefore, the ripple has to be subtracted to derive maximum DC current. The ripple current is a function of switching frequency, inductor value and duty cycle. The following equations take into account of all the above factors for maximum output current calculation.

$$I_p = \frac{1}{L \times F_s \times \left(\frac{1}{V_{out} + V_f - V_{in}} + \frac{1}{V_{in}} \right)} \quad (3)$$

Where

I_p = inductor peak to peak ripple

L = inductor value

V_f = Schottky diode forward voltage

F_s = switching frequency

V_{out} = output voltage of the boost converter. It is equal to the sum of V_{FB} and the voltage drop across LEDs.

$$I_{out_max} = \frac{V_{in} \times \left(I_{lim} - \frac{I_p}{2} \right) \times \eta}{V_{out}} \quad (4)$$

Where

I_{out_max} = maximum output current of the boost

converter

I_{lim} = over current limit

η = efficiency

Inductor Selection

The selection of the inductor affects steady state operation as well as transient behavior and loop stability. These factors make it the most important component in power regulator design. There are three important inductor specifications, inductor value, DC resistance and saturation current. Considering inductor value alone is not enough.

The inductor value determines the inductor ripple current. Choose an inductor that can handle the necessary peak current without saturating, according to half of the peak-to-peak ripple current given by Equation 3, plus the inductor DC current given by:

$$I_{in_DC} = \frac{V_{out} \times I_{out}}{V_{in} \times \eta} \quad (5)$$

Inductor values can have $\pm 20\%$ tolerance with no current bias. When the inductor current approaches saturation level, its inductance can decrease 20% to 35% from the 0A value depending on how the inductor vendor defines saturation current. Using an inductor with a smaller inductance value forces discontinuous PWM when the inductor current ramps down to zero before the end of each switching cycle. This reduces the boost converter's maximum output current, causes large input voltage ripple and reduces efficiency. Large inductance value provides much more output current and higher conversion efficiency. For these reasons, a 10 μ H to 22 μ H inductor value range is recommended. A 22 μ H inductor optimized the efficiency for most application while maintaining low inductor peak to peak ripple. When recommending inductor value, the factory has considered - 40% and +20% tolerance from its nominal value.

Schottky Diode Selection

The rectifier diode supplies current path to the inductor when the internal MOSFET is off. Use a schottky with low forward voltage to reduce losses. The diode should be rated for a reverse blocking voltage greater than the output voltage used. The average current rating must be greater than the maximum load current expected, and the peak current rating must be greater than the peak inductor current.

Diode the following requirements:

- Low forward voltage
- High switching speed : 50ns max.
- Reverse voltage : $V_{OUT} + V_F$ or more
- Rated current : I_{PK} or more

Compensation Capacitor Selection

The compensation capacitor C_{COMP} , connected from COMP pin to GND, is used to stabilize the feedback loop of the WD3148. A 220nF ceramic capacitor for C_{COMP} is suitable for most applications.

Input and Output Capacitor Selection

The output capacitor is mainly selected to meet the requirements for the output ripple and loop stability. This ripple voltage is related to the capacitor's capacitance and its equivalent series resistance (ESR). Assuming a capacitor with zero ESR, the minimum capacitance needed for a given ripple can be calculated by

$$C_{out} = \frac{(V_{out} - V_{in})I_{out}}{V_{out} \times F_s \times V_{ripple}} \quad (6)$$

Where, V_{ripple} = peak-to-peak output ripple. The additional output ripple component caused by ESR is calculated using:

$$V_{ripple_ESR} = I_{out} \times R_{ESR} \quad (7)$$

Due to its low ESR, V_{ripple_ESR} can be neglected for

ceramic capacitors, but must be considered if tantalum or electrolytic capacitors are used.

Care must be taken when evaluating a ceramic capacitor's derating under dc bias, aging and AC signal. For example, larger form factor capacitors (in 1206 size) have a resonant frequency in the range of the switching frequency. So the effective capacitance is significantly lower. The DC bias can also significantly reduce capacitance. Ceramic capacitors can lose as much as 50% of its capacitance at its rated voltage. Therefore, leave the margin on the voltage rating to ensure adequate capacitance at the required output voltage.

The capacitor in the range of $1\mu\text{F}$ to $10\mu\text{F}$ is recommended for input side. The output requires a capacitor in the range of $0.47\mu\text{F}$ to $10\mu\text{F}$. The output capacitor affects the loop stability of the boost regulator. If the output capacitor is below the range, the boost regulator can potentially become unstable.

Layout Consideration

As for all switching power supplies, especially those high frequency and high current ones, layout is an important design step. If layout is not carefully done, the regulator could suffer from instability as well as noise problems. To reduce switching losses, the LX pin rise and fall times are made as short as possible. To prevent radiation of high frequency resonance problems, proper layout of the high frequency switching path is essential. Minimize the length and area of all traces connected to the LX pin and always use a ground plane under the switching regulator to minimize inter-plane coupling. The loop including the PWM switch, Schottky diode, and output capacitor, contains high current rising and falling in nanosecond and should be kept as short as possible. The input capacitor needs not only to be close to the VIN pin, but also to the GND pin in order to reduce the IC supply ripple. Figure 2 shows a sample layout.

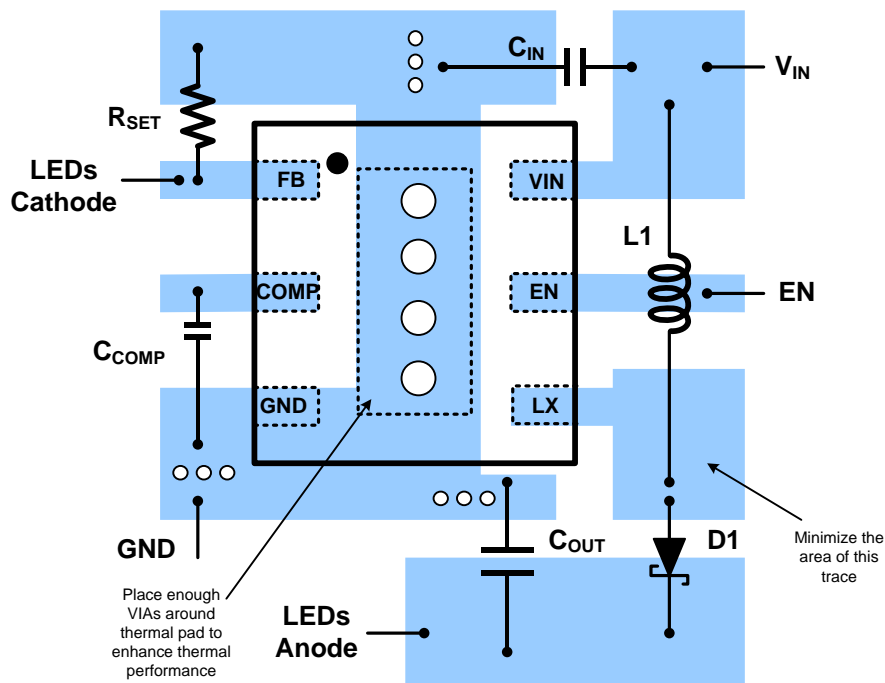

Figure 2. Sample Layout

Thermal consideration

The maximum IC junction temperature should be restricted to 125°C under normal operating conditions. This restriction limits the power dissipation of the WD3148. Calculate the maximum allowable dissipation, $P_{D(max)}$, and keep the actual dissipation less than or equal to $P_{D(max)}$. The maximum-power-dissipation limit is determined using Equation 8:

$$P_{D(max)} = \frac{125^{\circ}\text{C} - T_A}{R_{\theta JA}} \quad (8)$$

Where, T_A is the maximum ambient temperature for the application. $R_{\theta JA}$ is the thermal resistance junction-to-ambient given in Power Dissipation Table.

The WD3148 comes in DFN packages. Compared with the TSOT package, the DFN package has

better heat dissipation. This package includes a thermal pad that improves the thermal capabilities of the package. The θ_{JA} of the DFN package greatly depends on the PCB layout and thermal pad connection. The thermal pad must be soldered to the analog ground on the PCB. Using thermal vias underneath the thermal pad as illustrated in the layout example.

Additional Typical Applications

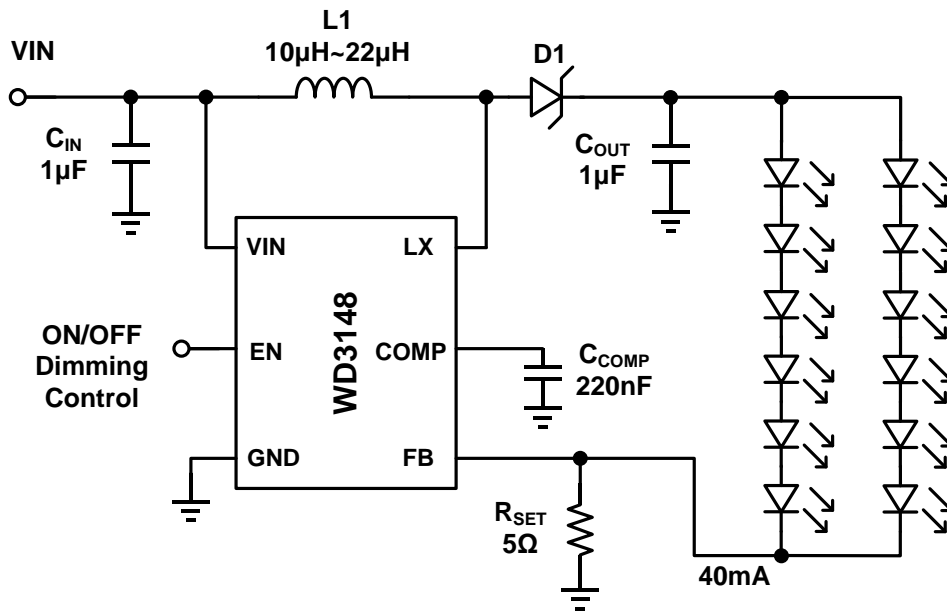

Figure 3 Li-Ion Driver for 6S2P White LEDs

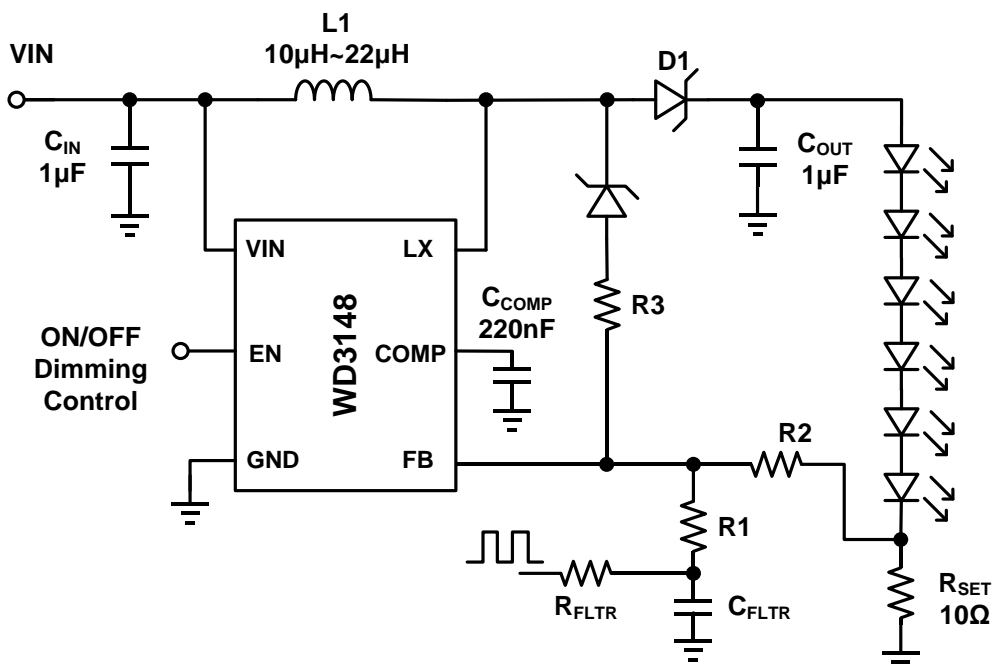

Figure 4 Li-Ion Driver for 6 White LEDs with External PWM Dimming Network

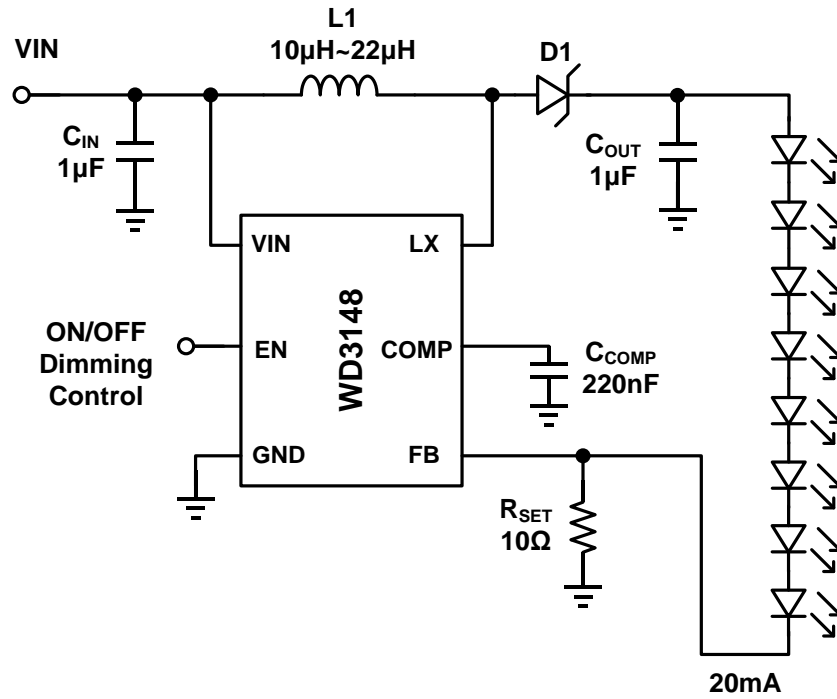
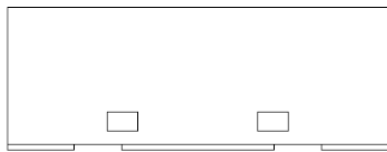
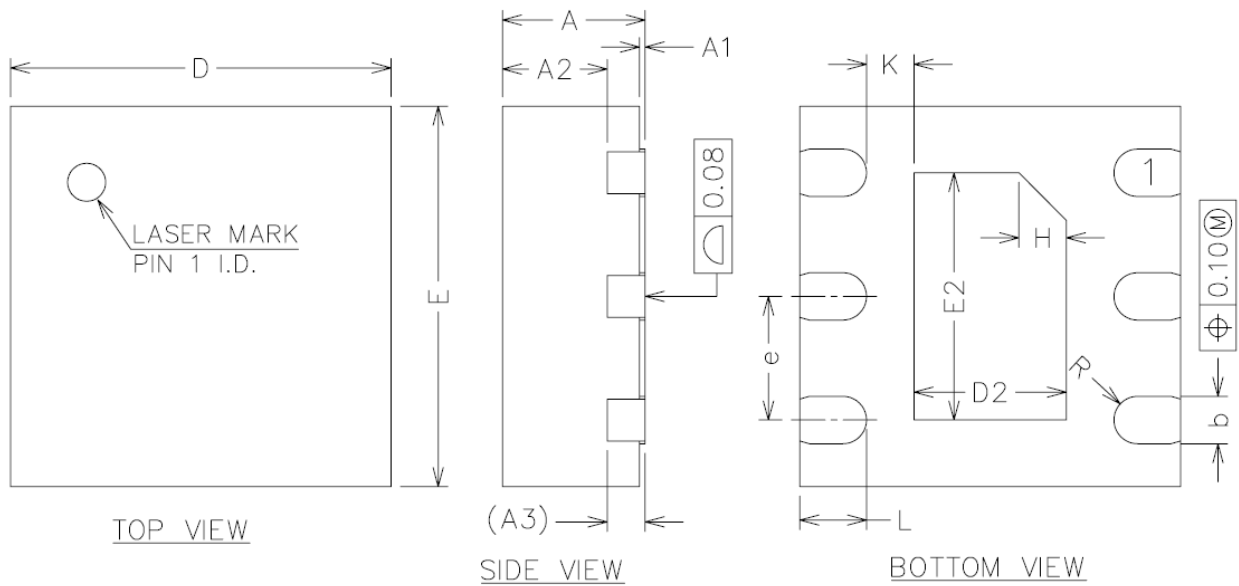

Figure 5 Li-Ion Driver for 8 White LED

Package outline dimensions
DFN-2x2-6L

SIDE VIEW

Symbol	Dimensions in millimeter		
	Min.	Nom.	Max.
A	0.70	0.75	0.80
A1	0.00	0.02	0.05
A2	0.5	0.55	0.6
A3	0.20 REF		
b	0.20	0.25	0.30
D	1.90	2.00	2.10
E	1.90	2.00	2.10
D2	0.70	0.80	0.90
E2	1.20	1.30	1.40
e	0.55	0.65	0.75
H	0.25 REF		
K	0.20	—	—
L	0.30	0.35	0.40
R	0.11	—	—