

# WL2810

**Low noise, High PSRR, High speed, CMOS LDO**

[Http://www.sh-willsemi.com](http://www.sh-willsemi.com)

## Descriptions

The WL2810 series is a high accuracy, low noise, high speed, low dropout CMOS Linear regulator with high ripple rejection. The devices offer a new level of cost effective performance in cellular phones, laptop and notebook computers, and other portable devices.



SOT-353

DFN1X1-4L

The WL2810 has the fold-back maximum output current which depends on the output voltage. So the current limit functions both as a short circuit protection and as an output current limiter.

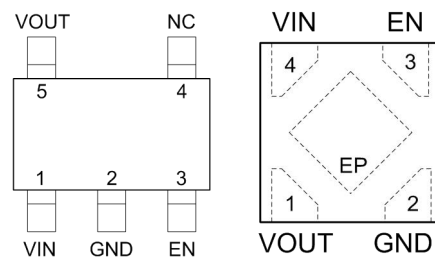

The WL2810 regulators are available in standard SOT-353 package and DFN1x1-4L Package. Standard products are Pb-free and Halogen-free.

**Pin Configuration (Top View)**

## Features

- Input voltage : 2.2V~5.5V
- Output range : 1.0V~3.3V
- Output current : 300mA
- PSRR : 70dB @ 217Hz
- Dropout voltage : 250mV @ I<sub>OUT</sub>=300mA
- Quiescent current : 42μA Typ.
- Shut-down current : < 1μA
- Recommend capacitor : 1uF

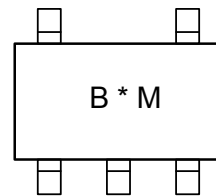

**B : Package Code**  
**\* : Voltage Code**  
**M: Month(A~L)**

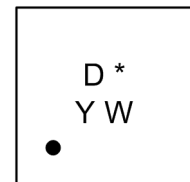

**D: Package Code**  
**\* : Voltage Code**  
**Y : Year Code**  
**W: Week Code**

For detail marking information, please see page 10.

## Marking

## Applications

- MP3/MP4 Players
- Cellphones, radiophone, digital cameras
- Bluetooth, wireless handsets
- Others portable electronics device

## Order Information

For detail order information, please see page 10.

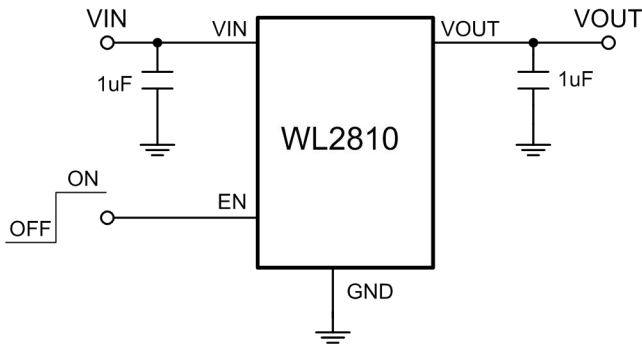
**Typical Application**

**Pin Description**
**SOT-353**

PIN	Symbol	Description
1	VIN	Input
2	GND	Ground
3	EN	Enable (Active high)
4	NC	Not connected
5	VOUT	Output

**DFN1X1-4L**

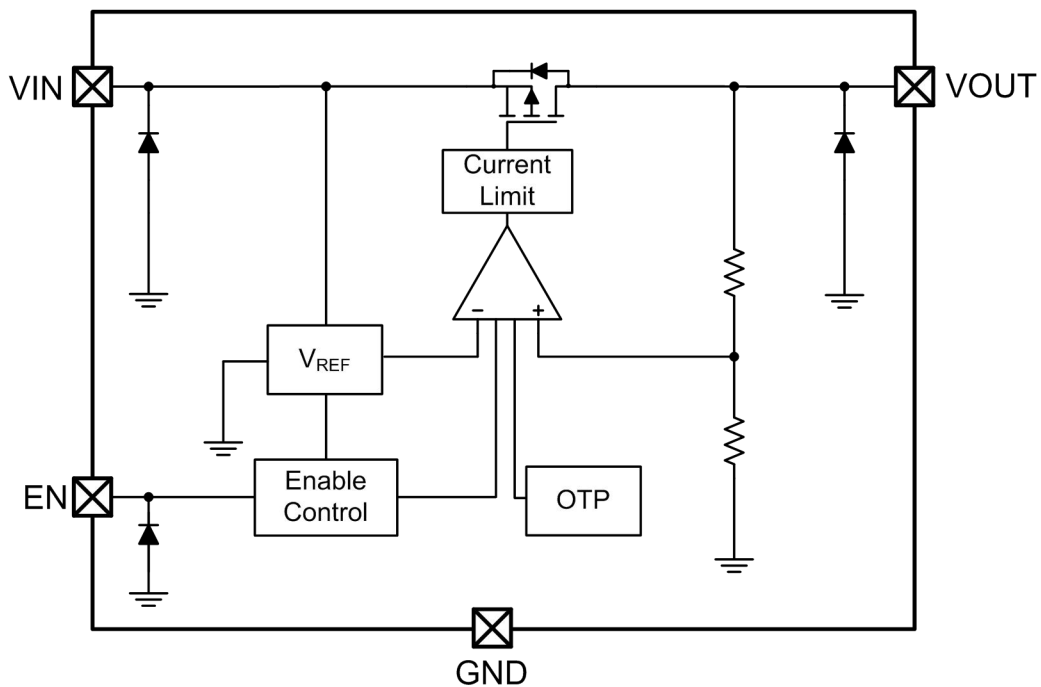
PIN	Symbol	Description
1	VOUT	Output
2	GND	Ground
3	EN	Enable (Active high)
4	VIN	Input
EP		GND level, this pin must connect to GND.

**Block Diagram**

**Absolute Maximum Ratings**

Parameter	Value	Unit	
Power Dissipation, $P_D@T_A=25^\circ\text{C}$	400	mW	
$V_{IN}$ Range	-0.3~6.5	V	
$V_{EN}$ Range	-0.3~ $V_{IN}$	V	
$V_{OUT}$ Range	-0.3~ $V_{IN}$	V	
$I_{OUT}$	400	mA	
Lead Temperature Range	260	$^\circ\text{C}$	
Storage Temperature Range	-55 ~ 150	$^\circ\text{C}$	
Operating Junction Temperature Range	150	$^\circ\text{C}$	
ESD Ratings	HBM	8000	V
	MM	400	V

**Recommend Operating Ratings**

Parameter	Value	Unit
Operating Supply voltage	2.2~5.5	V
Operating Temperature Range	-40~85	$^\circ\text{C}$
Thermal Resistance, $R_{\theta JA}$ (SOT-353)	250	$^\circ\text{C}/\text{W}$
Thermal Resistance, $R_{\theta JA}$ (DFN1x1-4L)	250	$^\circ\text{C}/\text{W}$

**Electronics Characteristics (Ta=25°C, V<sub>IN</sub>=V<sub>OUT</sub>+1V, C<sub>IN</sub>=C<sub>OUT</sub>=1μF, unless otherwise noted)**

Parameter	Symbol	Condition	Min.	Typ.	Max.	Unit
Output Voltage	V <sub>OUT</sub>	V <sub>OUT</sub> ≤ 1.5V, V <sub>IN</sub> =2.7V, I <sub>OUT</sub> =1mA	0.97 V <sub>OUT</sub>	V <sub>OUT</sub>	1.03 V <sub>OUT</sub>	V
		V <sub>OUT</sub> > 1.5V, I <sub>OUT</sub> =1mA	0.98 V <sub>OUT</sub>	V <sub>OUT</sub>	1.02 V <sub>OUT</sub>	
Current Limit	I <sub>LIM</sub>	V <sub>EN</sub> =V <sub>IN</sub>	300			mA
Dropout Voltage	V <sub>DROP</sub>	V <sub>OUT</sub> =3.3V, I <sub>OUT</sub> =300mA		220	330	mV
		V <sub>OUT</sub> =3.0V, I <sub>OUT</sub> =300mA		240	360	
		V <sub>OUT</sub> =2.8V, I <sub>OUT</sub> =300mA		250	375	
		V <sub>OUT</sub> =2.5V, I <sub>OUT</sub> =300mA		280	420	
		V <sub>OUT</sub> =1.8V, I <sub>OUT</sub> =300mA		400	600	
		V <sub>OUT</sub> ≤ 1.5V, I <sub>OUT</sub> =300mA	V <sub>in-min</sub> =2.2V			
Line Regulation	ΔV <sub>LINE</sub>	V <sub>IN</sub> =2.7~5.5V, I <sub>OUT</sub> =1mA		0.01	0.1	%/V
Load Regulation	ΔV <sub>Load</sub>	V <sub>OUT</sub> =2.8V, I <sub>OUT</sub> =1~300mA		10	30	mV
Quiescent Current	I <sub>Q</sub>	V <sub>OUT</sub> =2.8V, I <sub>OUT</sub> =0		42	70	μA
Short Current	I <sub>SHORT</sub>	V <sub>EN</sub> =V <sub>IN</sub> , V <sub>OUT</sub> Short to GND with 1Ω		80		mA
Shut-down Current	I <sub>SHDN</sub>	V <sub>EN</sub> =0V			1.0	μA
Power Supply Rejection Rate	PSRR	V <sub>IN</sub> =(V <sub>OUT</sub> +1V) <sub>DC</sub> +0.5V <sub>P-P</sub> F=217Hz, I <sub>OUT</sub> =10mA		70		dB
		V <sub>IN</sub> =(V <sub>OUT</sub> +1V) <sub>DC</sub> +0.5V <sub>P-P</sub> F=10KHz, I <sub>OUT</sub> =10mA		60		
EN logic high voltage	V <sub>ENH</sub>	V <sub>IN</sub> =5.5V, I <sub>OUT</sub> =1mA	1.2			V
EN logic low voltage	V <sub>ENL</sub>	V <sub>IN</sub> =5.5V, V <sub>OUT</sub> =0V			0.4	V
EN Input Current	I <sub>EN</sub>	V <sub>EN</sub> = 0 to 5.5V			1.0	μA
Output Noise Voltage	e <sub>NO</sub>	10Hz to 100KHz, C <sub>OUT</sub> =1μF		55		μV <sub>RMS</sub>
Thermal shutdown threshold	T <sub>SD</sub>			165		°C
Thermal shutdown hysteresis	Δ T <sub>SD</sub>			30		°C

Typical characteristics ( $T_a=25^\circ\text{C}$ ,  $V_{IN}=3.8\text{V}$ ,  $V_{OUT}=2.8\text{V}$ ,  $C_{IN}=C_{OUT}=1\mu\text{F}$ , unless otherwise noted)

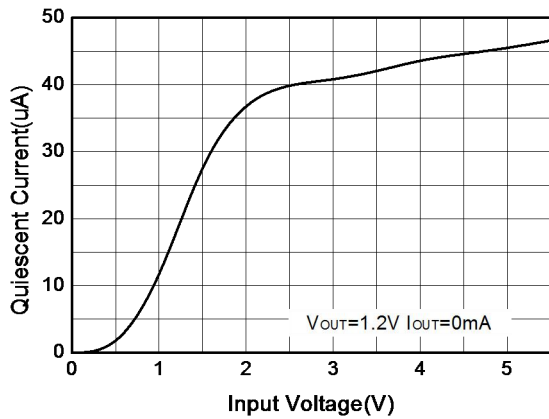

**Quiescent current vs. Supply voltage**

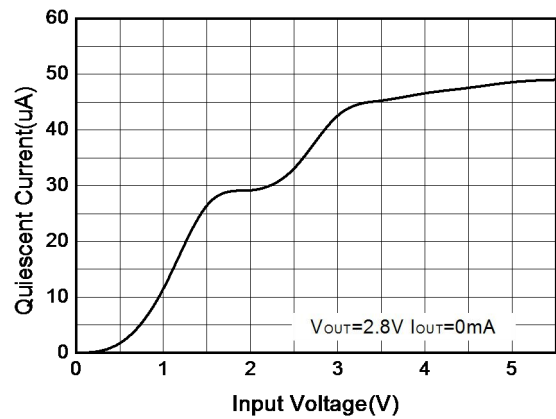

**Quiescent current vs. Supply voltage**

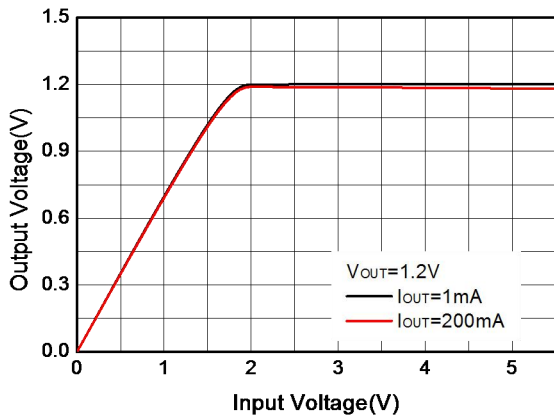

**Output voltage vs. Supply voltage**

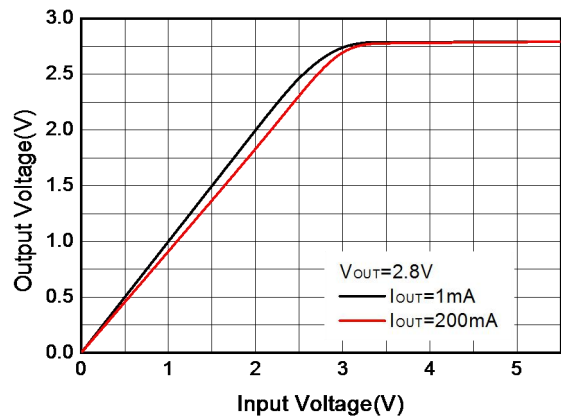

**Output voltage vs. Supply voltage**

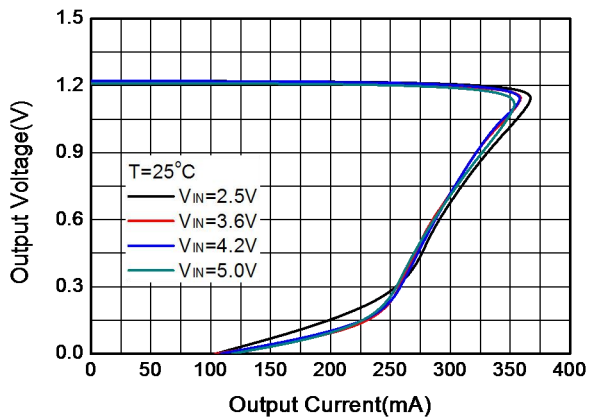

**Output voltage vs. Output current**

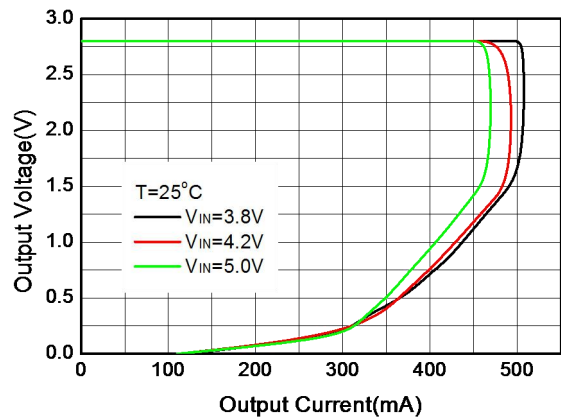

**Output voltage vs. Output current**

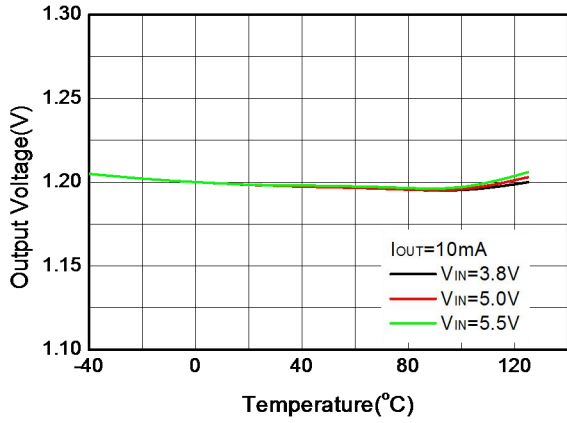
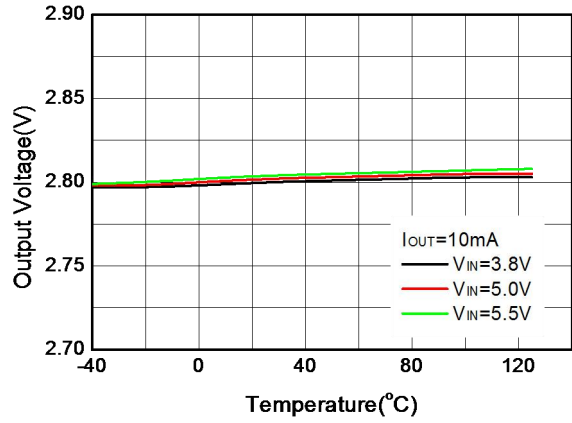
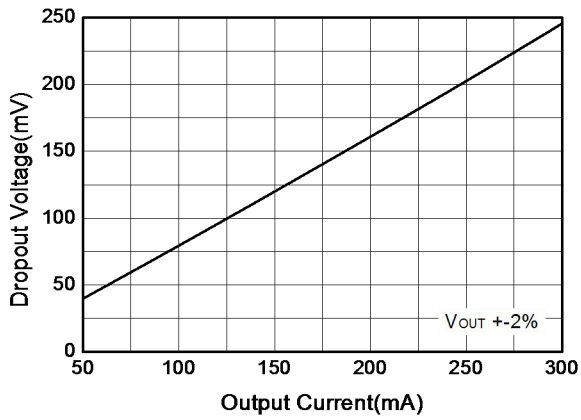
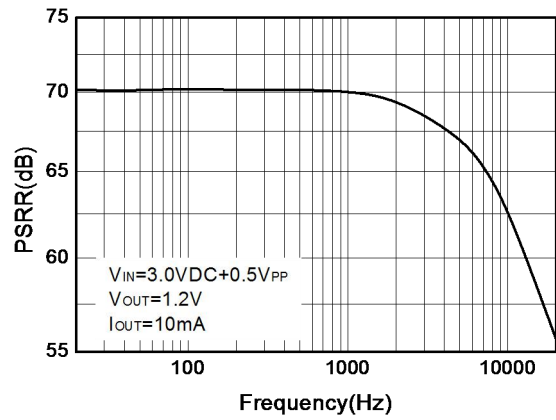

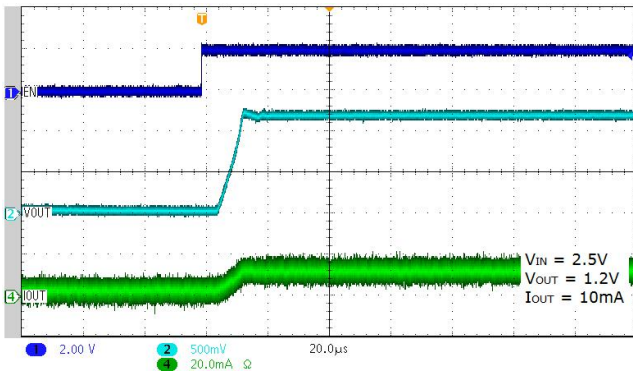
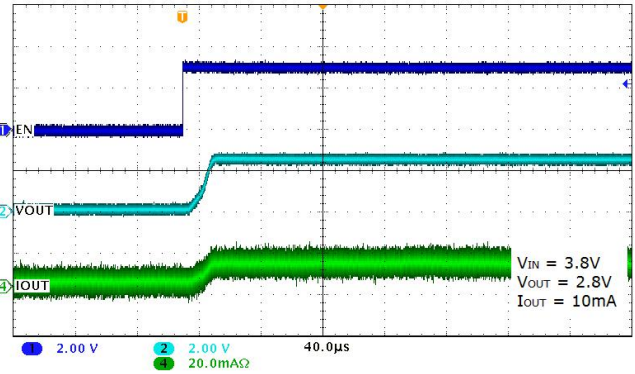
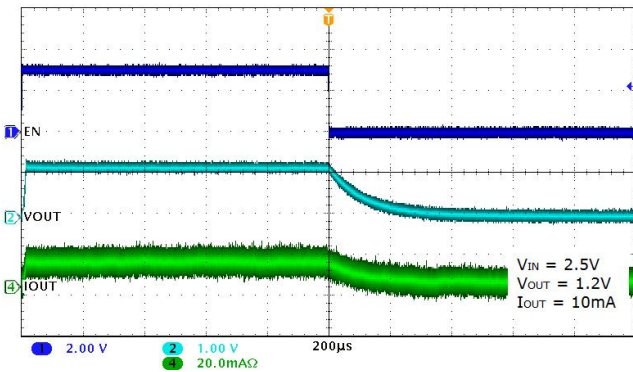
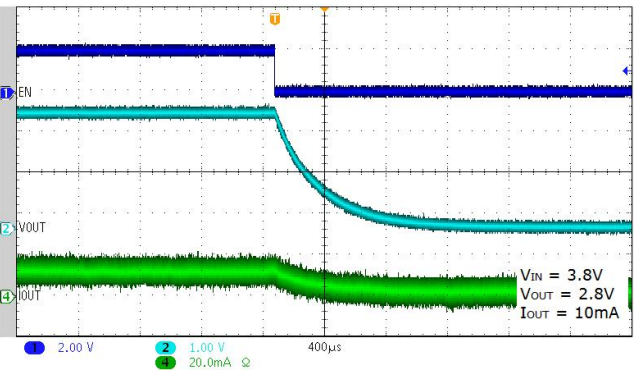
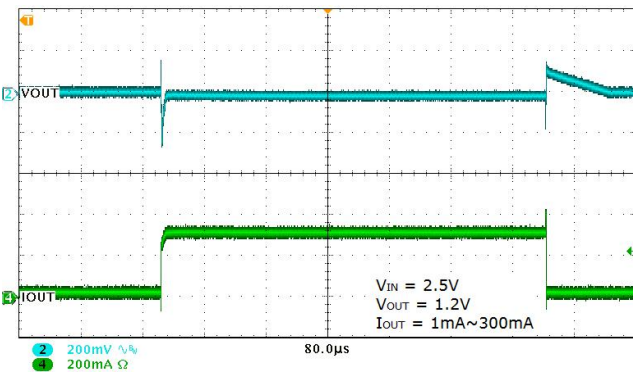
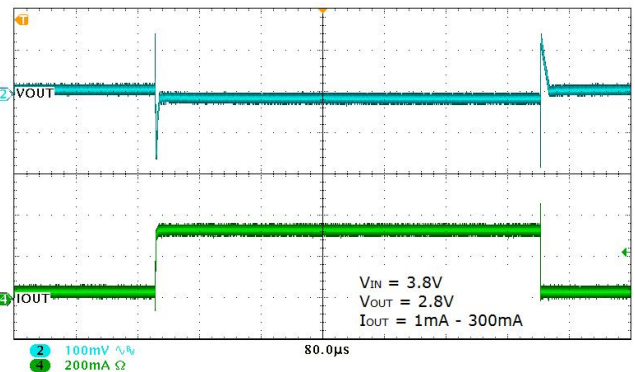
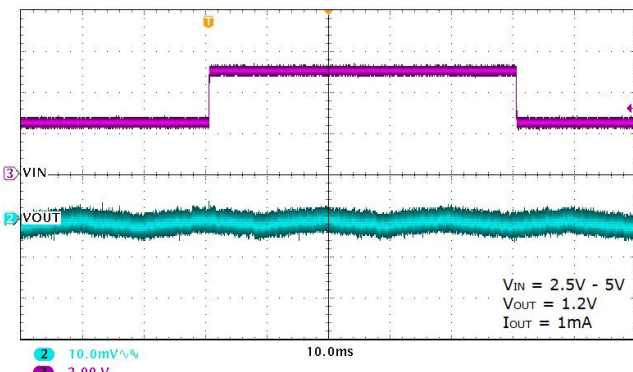
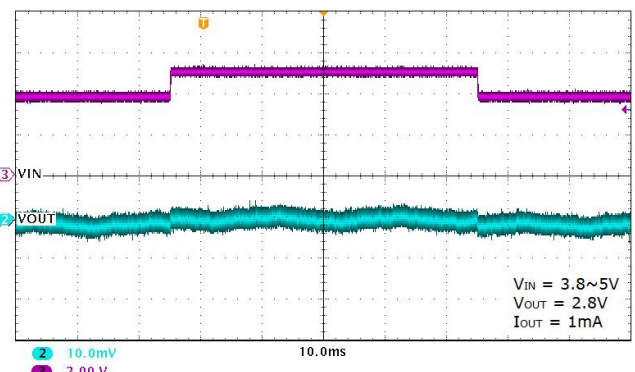
**Output Voltage vs. Temperature**

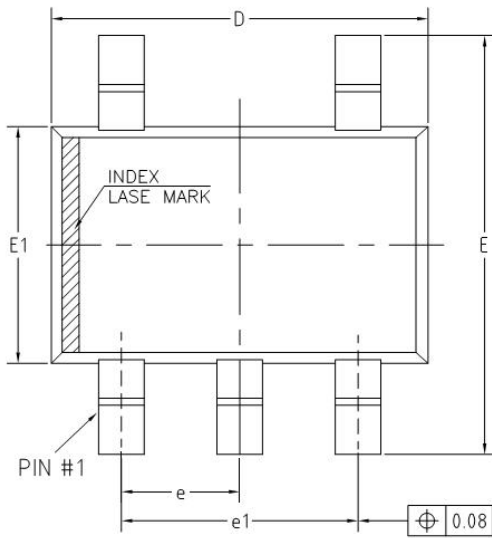
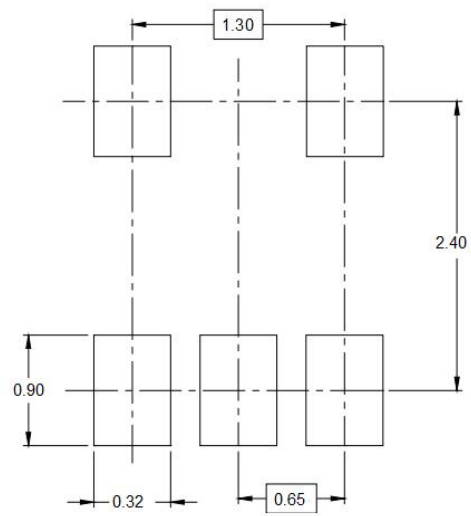
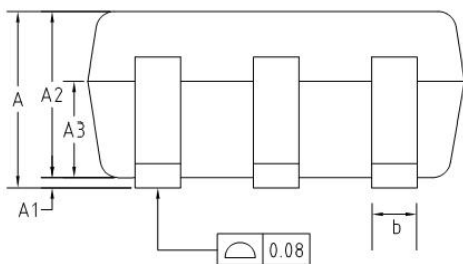
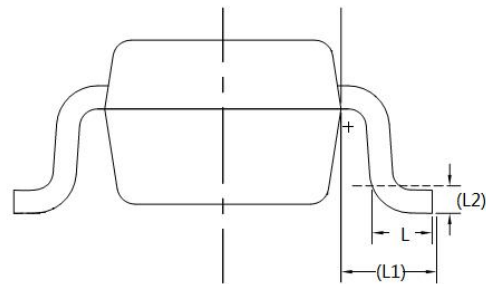
**Output Voltage vs. Temperature**

**Dropout Voltage vs. Output Current**

**PSRR**

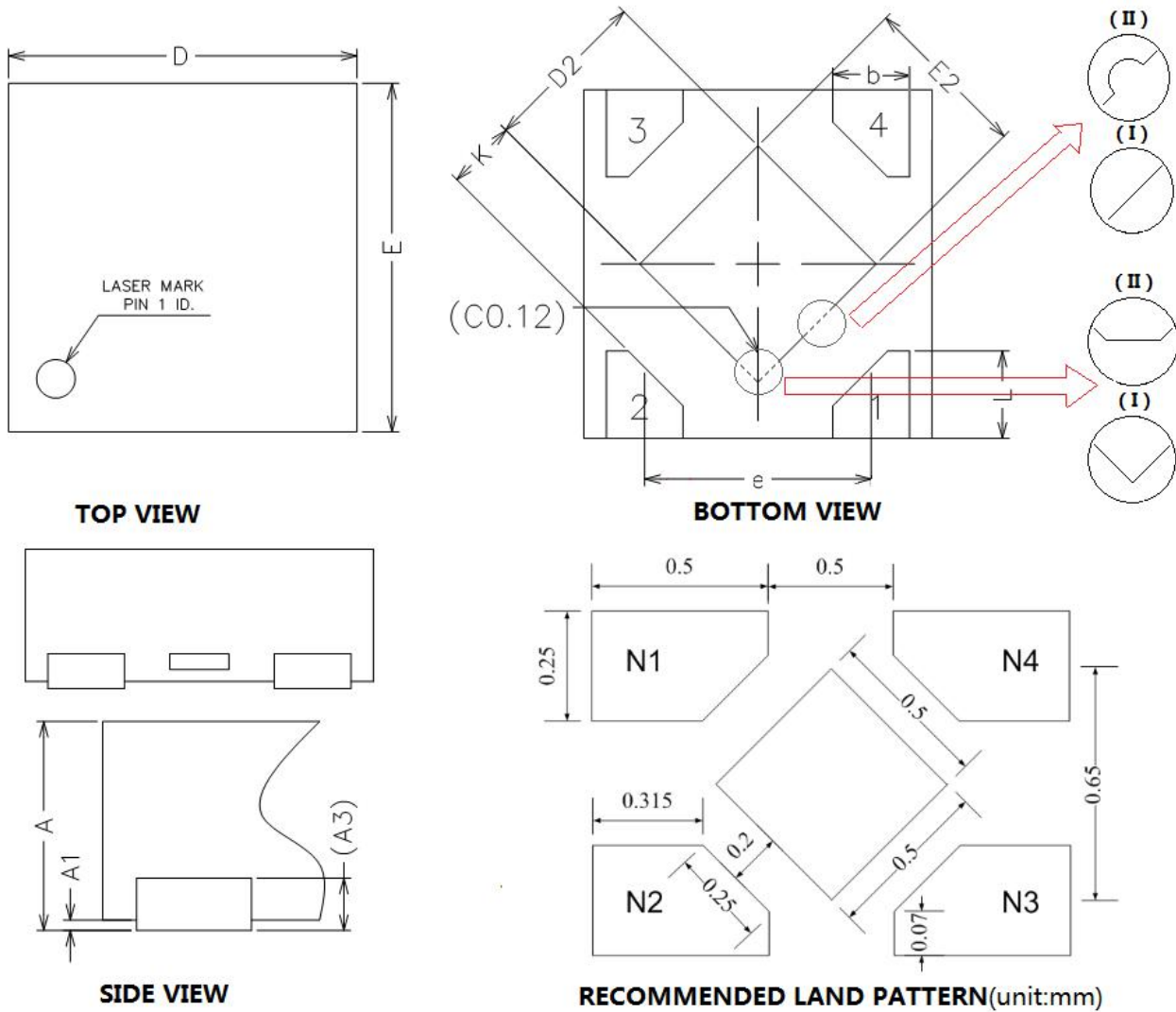
**Soft Start form EN**

**Soft Start form EN**

**EN Shutdown**

**EN Shutdown**

**Load Step**

**Load Step**

**Line Step**

**Line Step**

**Packaging Information**
**SOT-353**

**TOP VIEW**

**RECOMMENDED LAND PATTERN(unit:mm)**

**SIDE VIEW**

**SIDE VIEW**

Symbol	Dimensions In Millimeters		
	Min.	Typ.	Max.
A	0.85	-	1.05
A1	0.00	-	0.10
A2	0.80	0.90	1.00
A3	0.47	0.52	0.57
b	0.22	-	0.29
D	2.02	2.07	2.12
E	2.20	2.30	2.40
E1	1.25	1.30	1.35
e	0.65 BSC		
e1	1.30 BSC		
L	0.28	0.33	0.38
L1	0.50 REF		
L2	0.15 BSC		



**Packaging Information**
**DFN1x1-4L**

Symbol	Dimensions In Millimeters		
	Min.	Typ.	Max.
A	0.34	0.37	0.40
A1	0.00	0.02	0.105
A3	0.10 REF		
b	0.17	0.22	0.27
D	0.95	1.00	1.05
E	0.95	1.00	1.05
D2	0.43	0.48	0.53
E2	0.43	0.48	0.53
L	0.20	0.25	0.30
e	0.60	0.65	0.70
K	0.15	-	-

## ORDER INFORMATION

Ordering No.	Vout (V)	Package	Operating Temperature	Marking	Shipping
WL2810B12-5/TR	1.2	SOT-353	-40~+85°C	BEM	Tape and Reel, 3000
WL2810B15-5/TR	1.5	SOT-353	-40~+85°C	BGM	Tape and Reel, 3000
WL2810B18-5/TR	1.8	SOT-353	-40~+85°C	BHM	Tape and Reel, 3000
WL2810B28-5/TR	2.8	SOT-353	-40~+85°C	BLM	Tape and Reel, 3000
WL2810B30-5/TR	3.0	SOT-353	-40~+85°C	BMM	Tape and Reel, 3000
WL2810B33-5/TR	3.3	SOT-353	-40~+85°C	BNM	Tape and Reel, 3000
WL2810D10-4/TR	1.0	DFN1x1-4L	-40~+85°C	DB YW	Tape and Reel, 10000
WL2810D105-4/TR	1.05	DFN1x1-4L	-40~+85°C	DC YW	Tape and Reel, 10000
WL2810D12-4/TR	1.2	DFN1x1-4L	-40~+85°C	DE YW	Tape and Reel, 10000
WL2810D13-4/TR	1.3	DFN1x1-4L	-40~+85°C	DF YW	Tape and Reel, 10000
WL2810D15-4/TR	1.5	DFN1x1-4L	-40~+85°C	DG YW	Tape and Reel, 10000
WL2810D18-4/TR	1.8	DFN1x1-4L	-40~+85°C	DH YW	Tape and Reel, 10000
WL2810D25-4/TR	2.5	DFN1x1-4L	-40~+85°C	DK YW	Tape and Reel, 10000
WL2810D28-4/TR	2.8	DFN1x1-4L	-40~+85°C	DL YW	Tape and Reel, 10000
WL2810D30-4/TR	3.0	DFN1x1-4L	-40~+85°C	DM YW	Tape and Reel, 10000
WL2810D33-4/TR	3.3	DFN1x1-4L	-40~+85°C	DN YW	Tape and Reel, 10000

**Marking:**

- B\*** = Device Code
- D\*** = Device Code
- M** = Month
- Y** = Year
- W** = Week