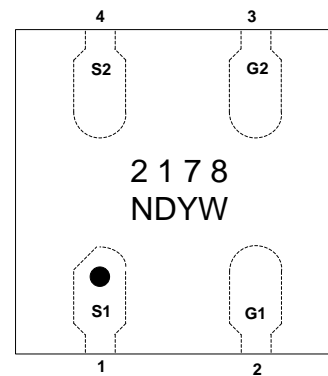

WNMD2178
Dual N-Channel, 20V, 6A, Power MOSFET
www.sh-willsemi.com

V _{SSS} (V)	Typ R _{SS(on)} (mΩ)
20	23.5@ V _{GS} =4.5V
	24@ V _{GS} =4.0V
	26@ V _{GS} =3.1V
	29@ V _{GS} =2.5V
ESD Rating:2000V HBM	

Descriptions

The WNMD2178 is Dual N-Channel enhancement MOS Field Effect Transistor and connecting the Drains on the circuit board is not required because the Drains of the MOSFET1 and the MOSFET2 are internally connected. Uses advanced trench technology and design to provide excellent R_{SS(ON)} with low gate charge. This device is designed for Lithium-Ion battery protection circuit. The WNMD2178 is available in DFN2X2-4L package. Standard Product WNMD2178 is Pb-free and Halogen-free.

Bottom View
DFN2X2-4L

4: Source 2 3: Gate 2

1: Source 1 2: Gate 1

2178 = Device Code

ND =Special Code

Y = Year

W = Week (A~z)

Features

- Trench Technology
- Supper high density cell design
- Excellent ON resistance for higher DC current
- Extremely Low Threshold Voltage
- Small package DFN2X2-4L

Pin configuration (TOP view)&Marking
Applications

- Lithium-Ion battery protection circuit

Order information

Device	Package	Shipping
WNMD2178-4/TR	DFN2X2-4L	3000/Reel&Tape

Electronics Characteristics (Ta=25°C, unless otherwise noted)

Parameter	Symbol	Test Conditions	Min	Typ	Max	Unit
OFF CHARACTERISTICS						
Source to Source Voltage	V _{SSS}	V _{GS} = 0 V, I _S = 250uA	20			V
Zero Gate Voltage Drain Current	I _{SSS}	V _{SS} = 16 V, V _{GS} = 0V TEST CIRCUIT 1			1	uA
Gate Leakage Current	I _{GSS}	V _{SS} = 0 V, V _{GS} = ±12V TEST CIRCUIT 2			±10	uA
ON CHARACTERISTICS						
Gate to Source Cut-off Voltage	V _{GS(off)}	V _{GS} = V _{SS} , I _S = 250uA TEST CIRCUIT 3	0.4	0.72	1.0	V
Source to Source On-state Resistance	R _{SS(on)}	V _{GS} = 4.5V, I _S = 6.0A TEST CIRCUIT 5	17	23.5	31	mΩ
		V _{GS} = 4.0V, I _S = 6.0A TEST CIRCUIT 5	17	24	33	
		V _{GS} = 3.1V, I _S = 6.0A TEST CIRCUIT 5	19	26	43	
		V _{GS} = 2.5V, I _S = 5.0A TEST CIRCUIT 5	20	29	52	
Forward Transfer Admittance	y _{fs}	V _{SS} = 5 V, I _S = 1.8A TEST CIRCUIT 4		11		S
BODY DIODE CHARACTERISTICS						
Body Diode Forward Voltage	V _{F(S-S)}	V _{GS} = 0 V, I _F = 1.0A TEST CIRCUIT 6			1.5	V
SWITCHING CHARACTERISTICS						
Turn-On Delay Time	td(ON)	V _{GS} = 4.5 V, V _{SS} = 10V, I _S = 3A, R _G = 6Ω TEST CIRCUIT 8		572		ns
Rise Time	tr			2108		
Turn-Off Delay Time	td(OFF)			5880		
Fall Time	tf			4960		
CHARGES, CAPACITANCES AND GATE RESISTANCE						
Input Capacitance	C _{ISS}	V _{GS} = 0 V, f = 1kHz, V _{SS} = 10 V TEST CIRCUIT 7		1240		pF
Output Capacitance	C _{OSS}			332		
Reverse Transfer Capacitance	C _{RSS}			189		
Total Gate Charge	Q _{G(TOT)}	V _{G1S1} = 4.5 V, V _{SS} = 10V, I _S = 6A TEST CIRCUIT 9		17.8		nC
Threshold Gate Charge	Q _{G(TH)}			0.65		
Gate-to-Source Charge	Q _{GS}			2.5		
Gate-to-Drain Charge	Q _{GD}			5.1		

Absolute Maximum ratings

Parameter	Symbol	10 s	Steady State	Unit
Source to Source Voltage ($V_{GS} = 0\text{ V}$)	V_{SSS}	20		V
Gate to Source Voltage ($V_{SS} = 0\text{ V}$)	V_{GSS}	± 12		
Source Current (pulse) ^{Note.c}	$I_{S(\text{pulse})}$	60		A
Source Current (DC)	I_S	6		A
Channel Temperature	T_{ch}	150		$^{\circ}\text{C}$
Storage Temperature Range	T_{stg}	-55 to 150		$^{\circ}\text{C}$

Note.c $PW \leq 10\mu\text{s}$, duty cycle $\leq 1\%$;

Both the FET1 and the FET2 are measured. Test circuits are example of measuring the FET1 side.

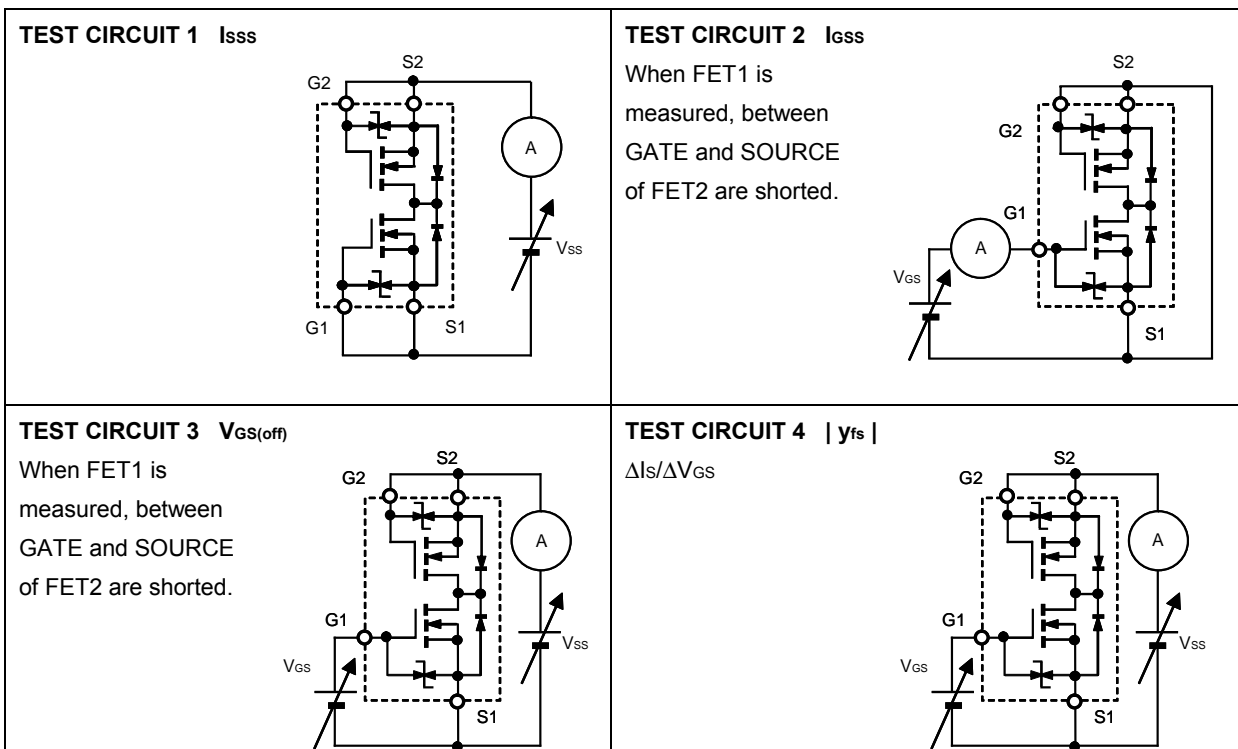

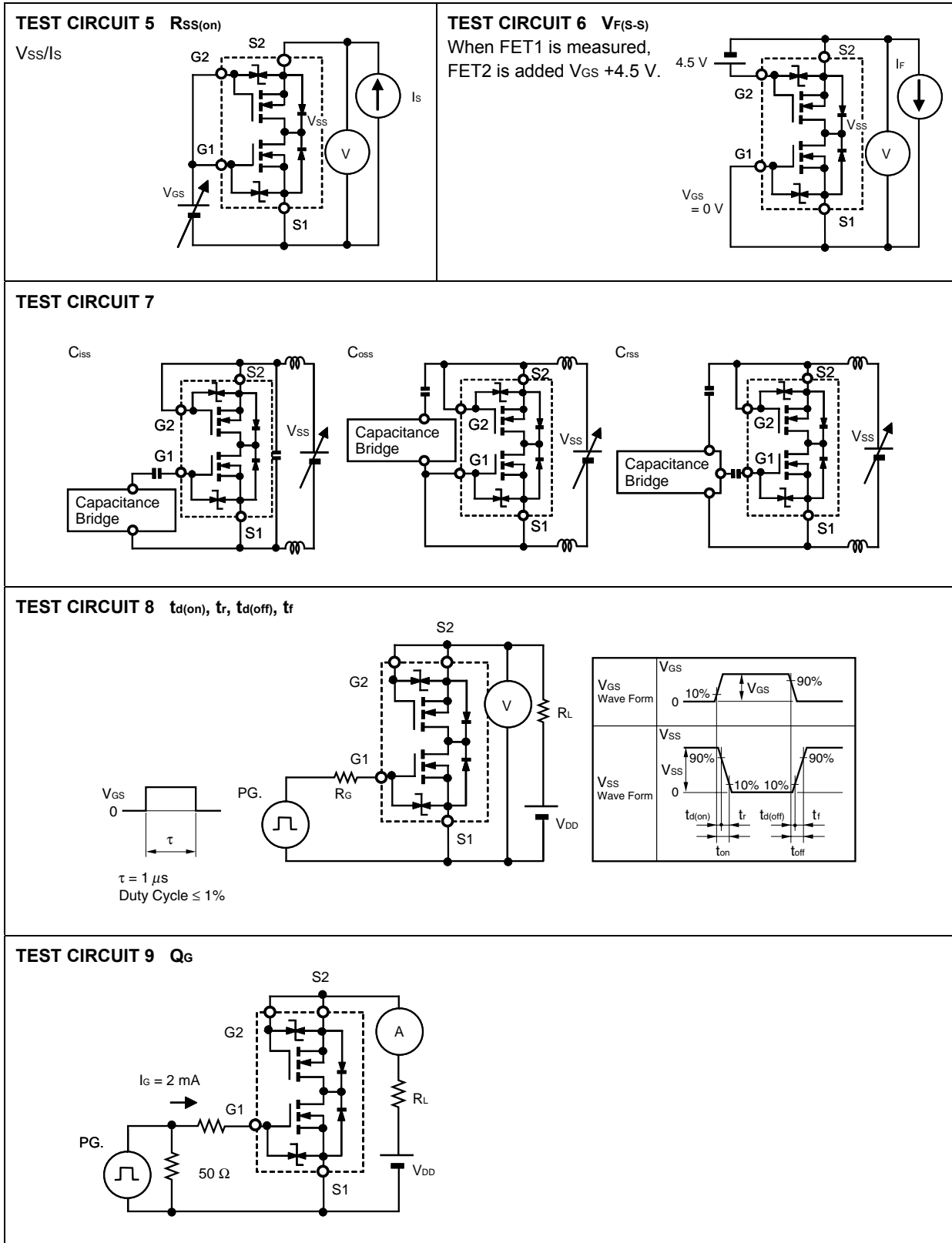

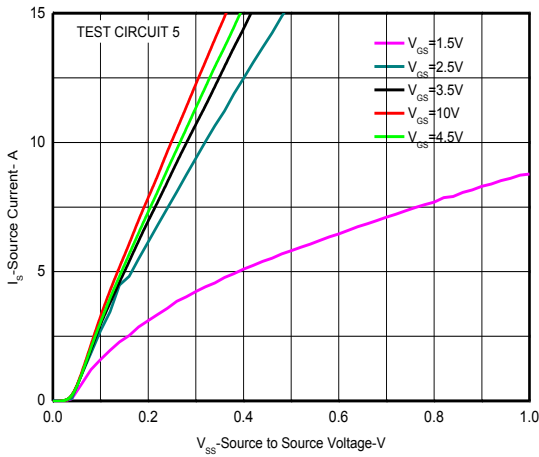
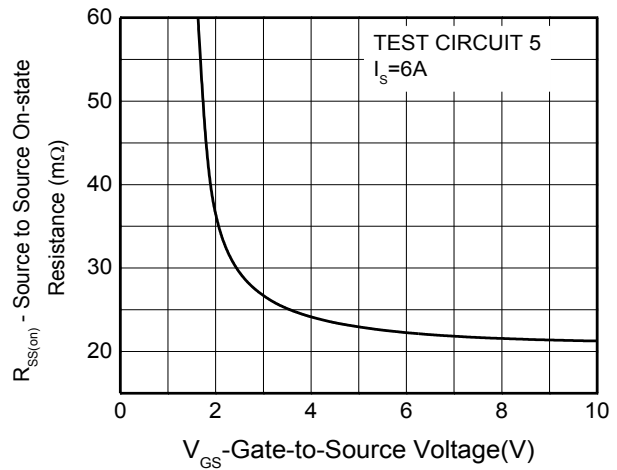
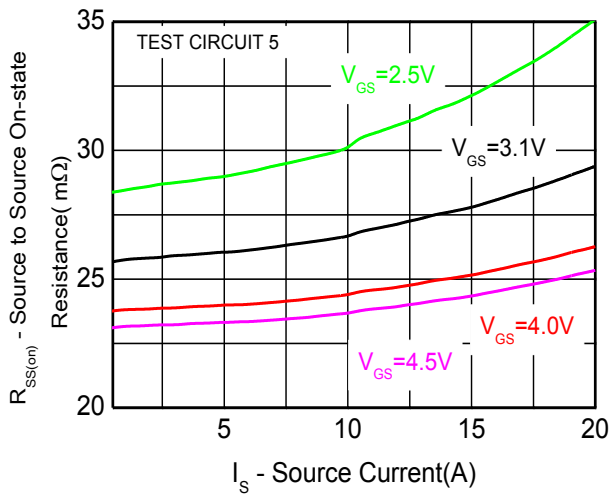
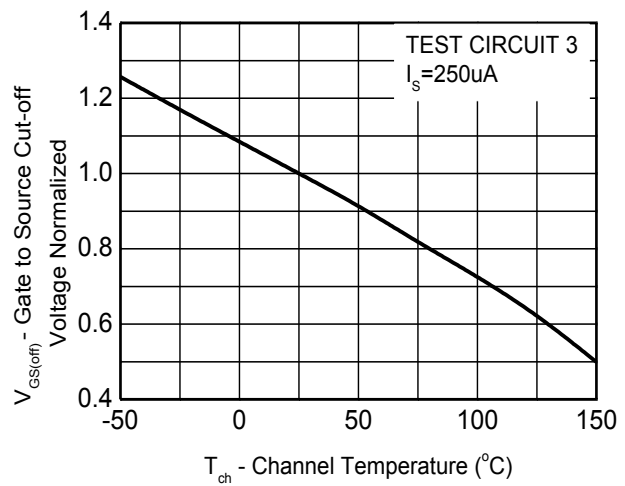
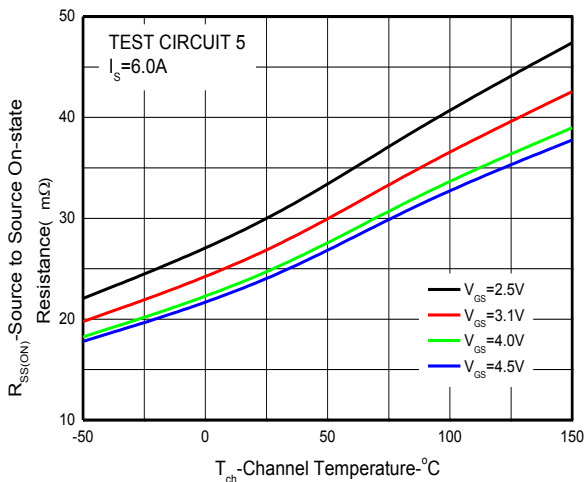
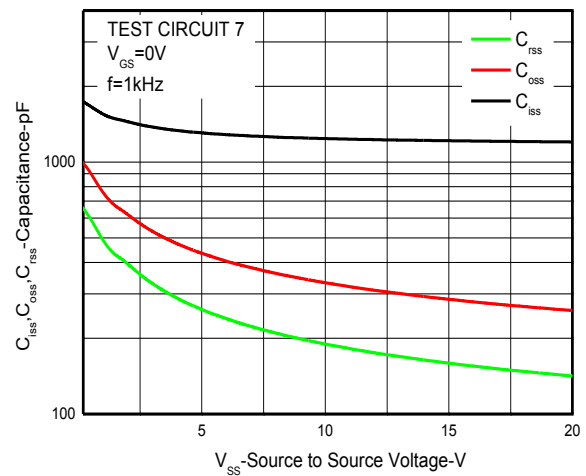
Typical Characteristics (Ta=25°C, unless otherwise noted)

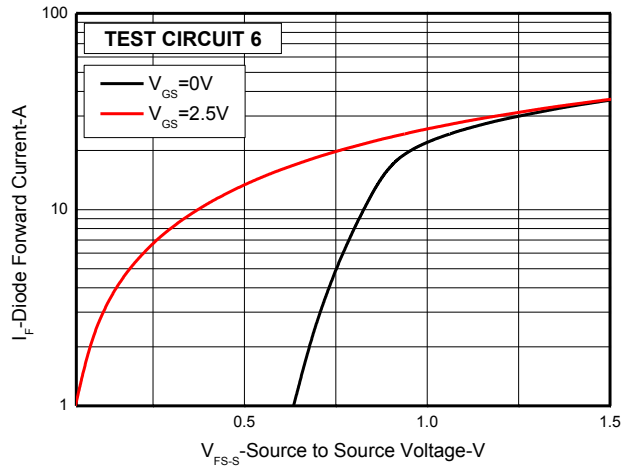
SOURCE CURRENT vs.
SOURCE TO SOURCE VOLTAGE

SOURCE TO SOURCE ON-STATE RESISTANCE vs.
GATE TO SOURCE VOLTAGE

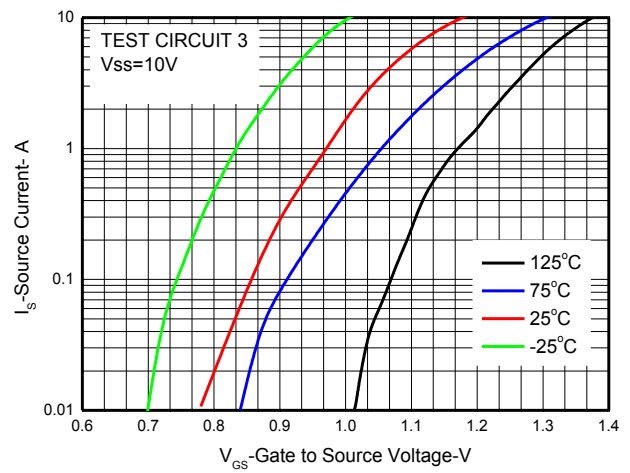
SOURCE TO SOURCE ON-STATE RESISTANCE vs.
SOURCE CURRENT

GATE TO SOURCE CUT-OFF VOLTAGE vs.
CHANNEL TEMPERATURE

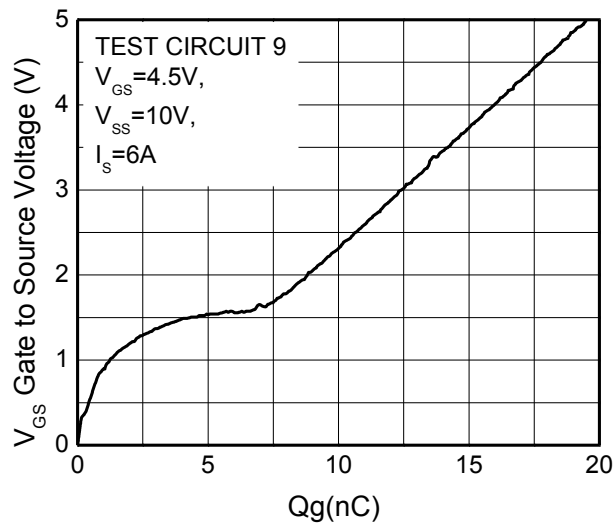
SOURCE TO SOURCE ON-STATE RESISTANCE vs.
CHANNEL TEMPERATURE

CAPACITANCE vs. SOURCE TO SOURCE VOLTAGE



SOURCE TO SOURCE DIODE FORWARD VOLTAGE



FORWARD TRANSFER CHARACTERISTICS

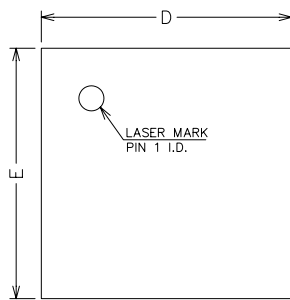

DYNAMIC INPUT CHARACTERISTICS

Package outline dimensions
DFN2X2-4L

TOP VIEW

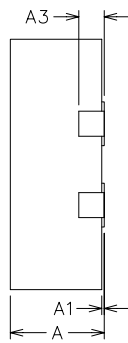

SIDE VIEW

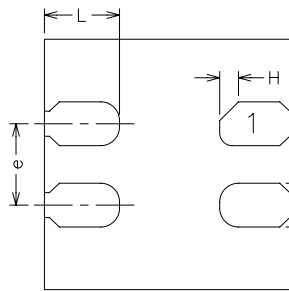

BOTTOM VIEW

 COMMON DIMENSIONS
 (UNITS OF MEASURE=MILLIMETER)

SYMBOL	MIN	NOM	MAX
A	0.70	0.75	0.80
A1	0.00	0.02	0.05
A3	0.203 REF		
b	0.30	0.35	0.40
D	1.90	2.00	2.10
E	1.90	2.00	2.10
e	0.55	0.65	0.75
L	0.55	0.60	0.65
H	0.15 REF		

NOTES:
 ALL DIMENSIONS DO NOT INCLUDE MOLD FLASH OR PROTRUSIONS.